

# UNIC Virtual Campus Basic Information and Implementation Overview



# UNIC VC Basics



## What we agreed upon

- What virtual campus is not
- What virtual campus is
- Basic set of rules



## What UNIC Virtual Campus is not

- It is not a UNIC web site, it is a set of applications that blend in the UNIC web site
- It does not serve as a place to put news etc.
- It is not a comprehensive database nor it has any intention to be



# What is UNIC Virtual Campus?

- An information system (database, applications, APIs, procedures, organization, support ...)
- A central hub for data exchange between alliance members
- A support for common UNIC processes
- A central information exchange component of the consortium



## Basic set of rules

- All participating universities has to have an electronical identity provider (IdP)
  - In Croatia: AAI@EduHr
- IdP has to participate in eduGAIN
- All students have to have ESI (European Student Identifier)
  - In Croatia JMBAG serves as ESI
- VC will use ECTS grading scale (A-F) – everyone has to know how to convert their grades to ECTS grades



# Our vision: Main functionalities of the UNIC VC

- Interoperable / acts as a part of UNIC website
- Provides public access to some information as well protected access to authorized users
- Supports:
  - UNIC European Student Card
  - Course catalogue
  - Joint-8 programmes catalogue
  - Virtual mobility – course selection, enrolment, grade exchange
  - Open Science Campus (UNIC4ER)
  - ...
- Holds minimal set of data in order to support the processes
- Heavily relies on data exchange
  - Most data in the VC should origin in other systems
  - UNIC VC connects the dots, builds the top layer on that available data
  - A small set of data and actions is needed to be done inside the VC apps



# UNIC VC interactions

- All users that log in to the system use their own electronical identity (given by the home university)

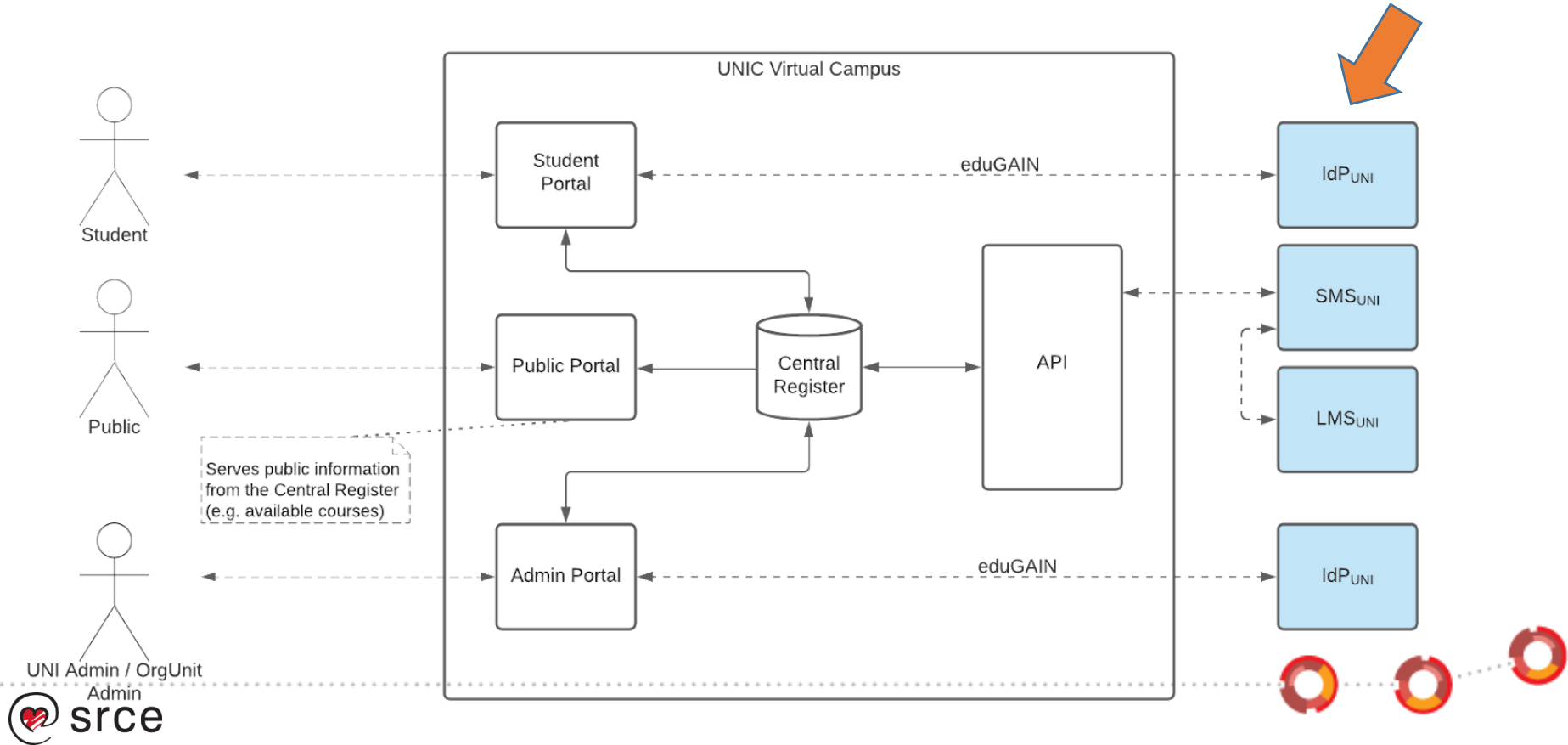



# UNIC VC interactions

- Provides an API so local student management systems (SMSs) can interact with it and push/pull the data

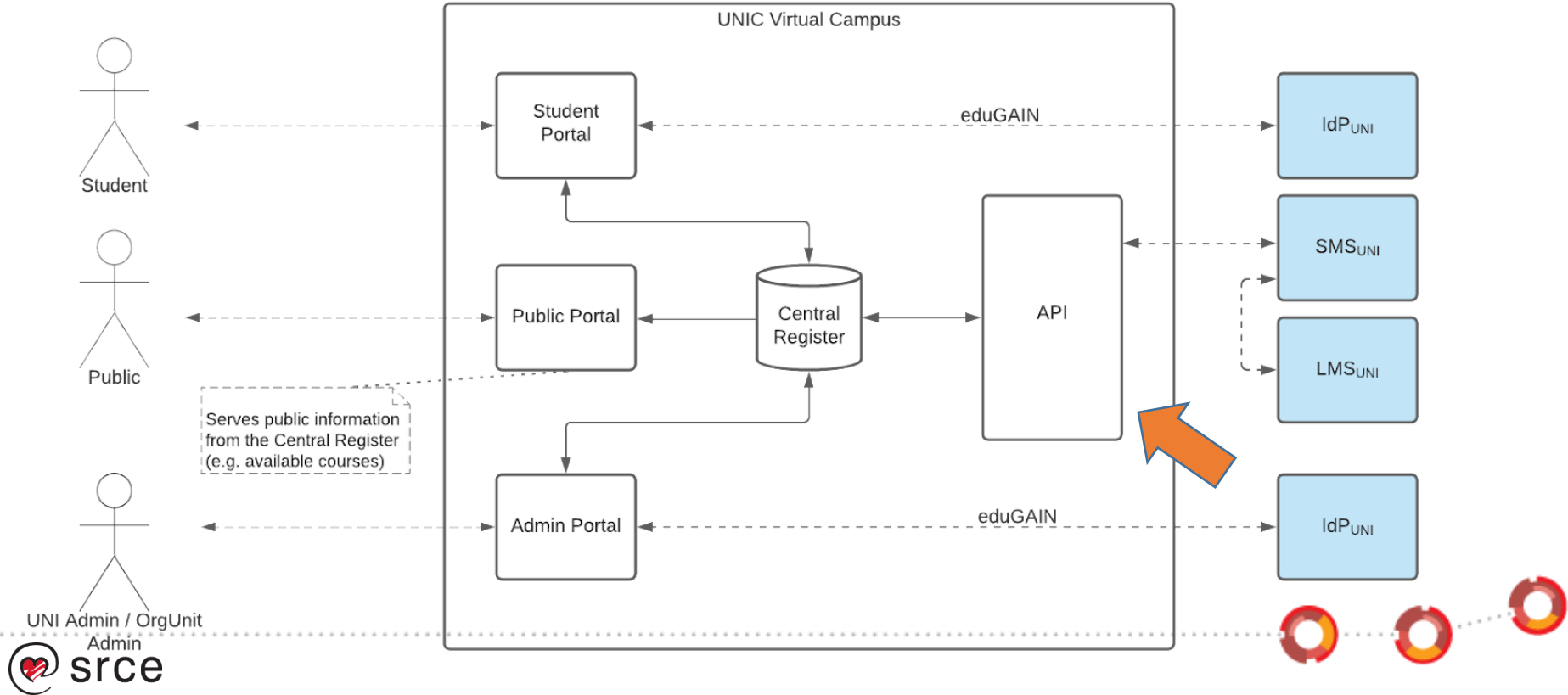

# UNIC VC interactions

- Provides web applications through the Admin Portal, so the universities which are not ready for the data exchange can still use the system

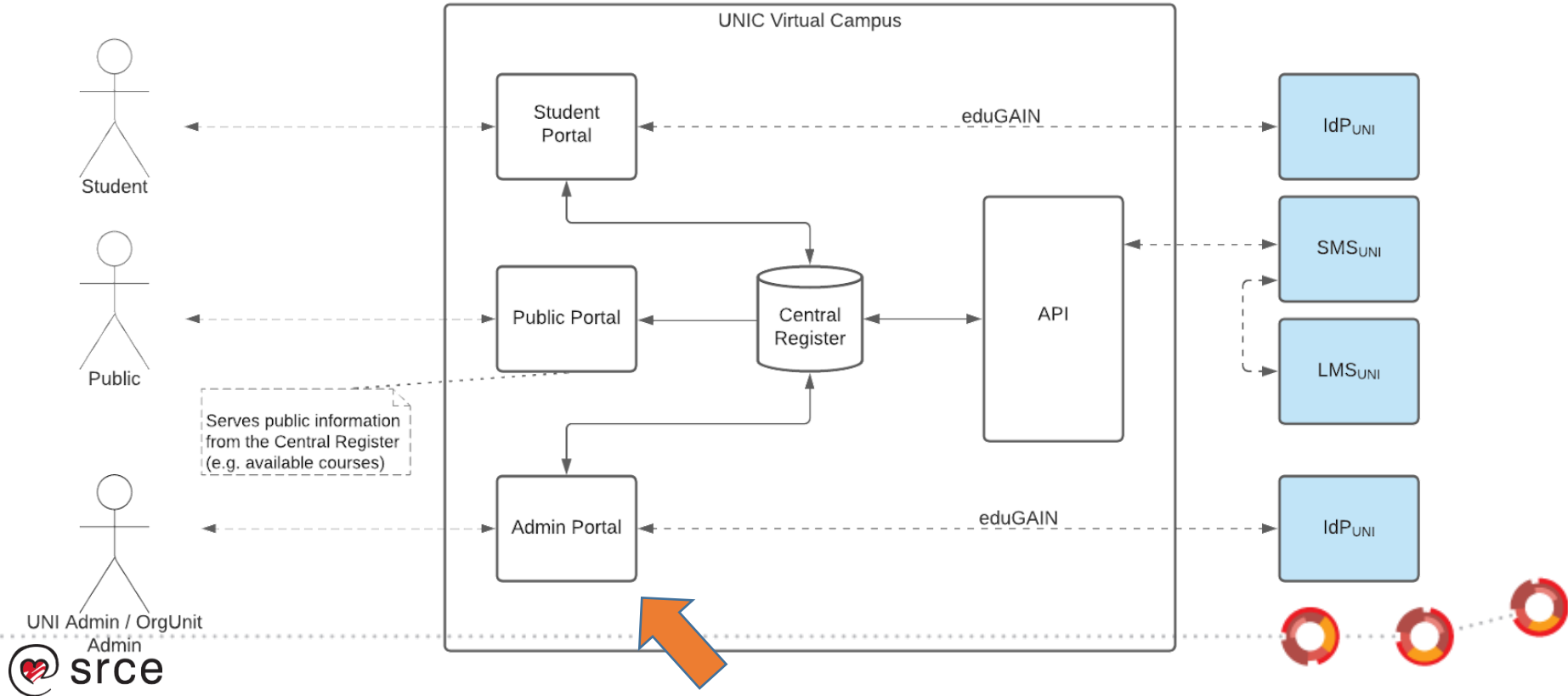

# UNIC VC interactions

- For successful implementation, the link between UNIC VC and local SMSs is crucial

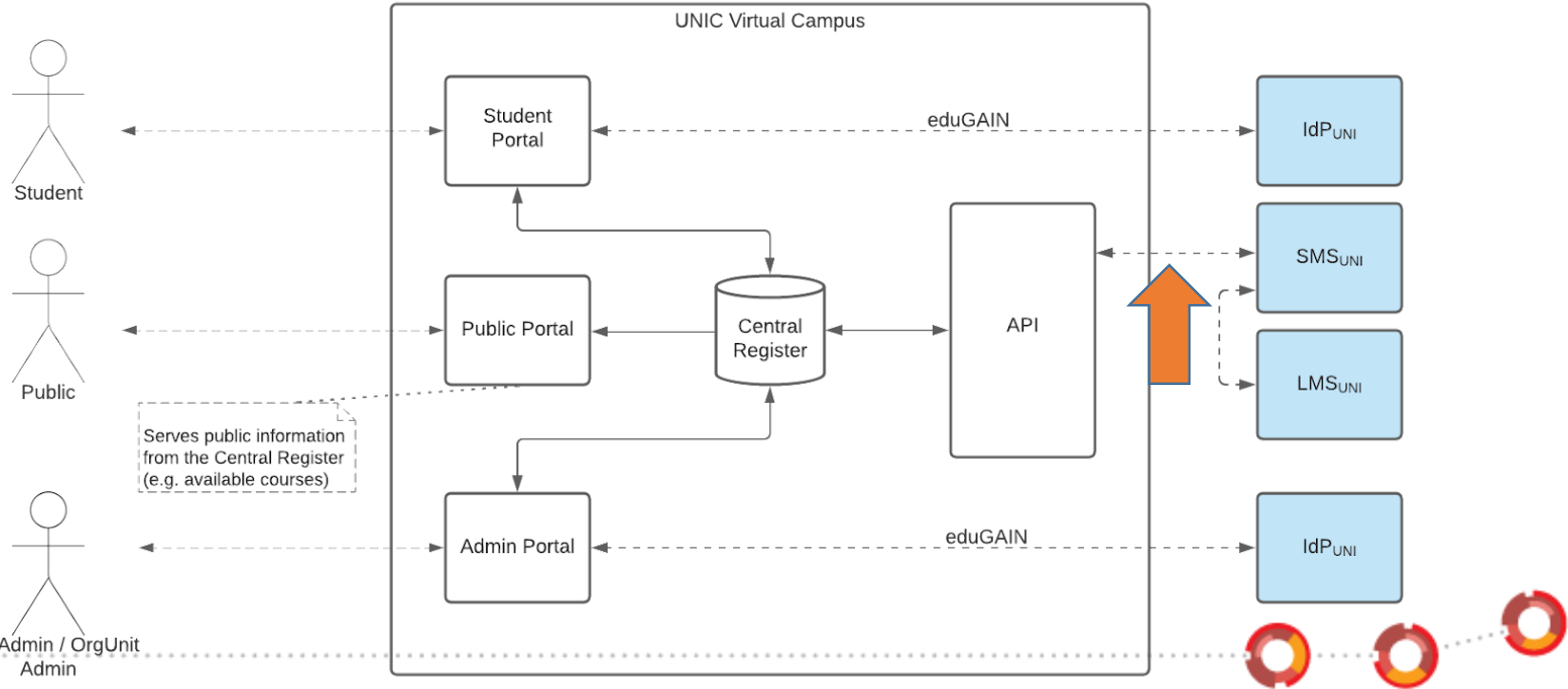

# Future outlook (fall 2023)

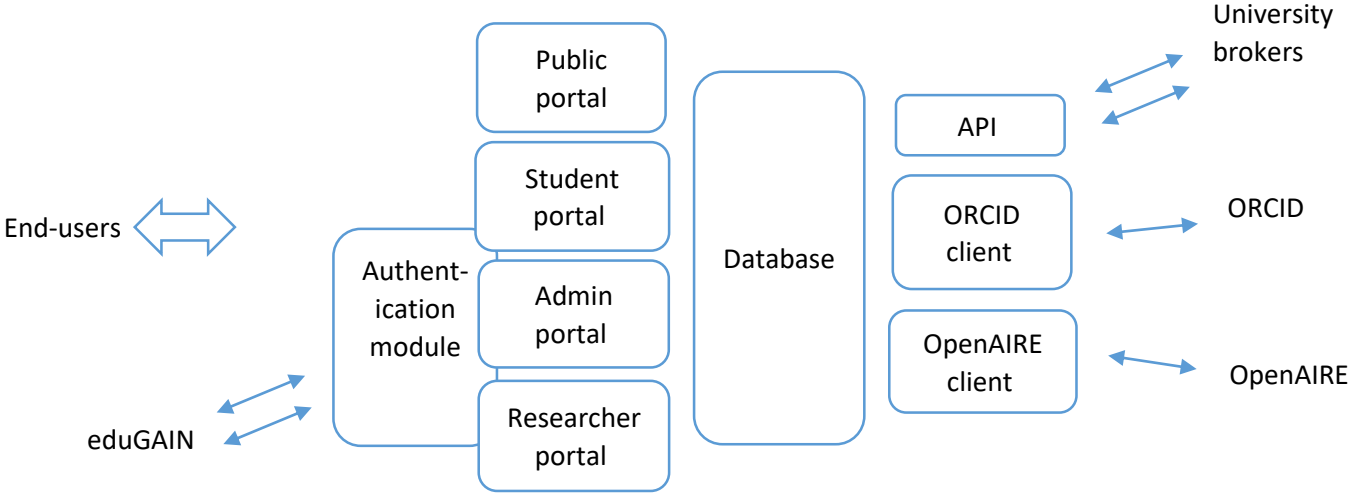

# VC – UNI infrastructure interaction

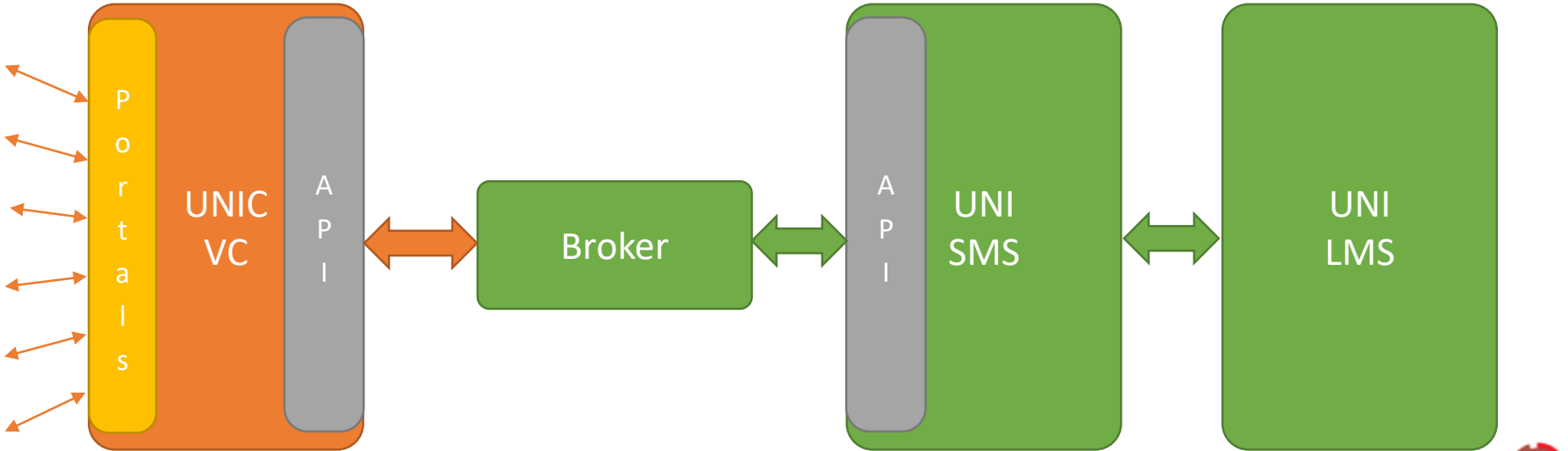

# VC – UNI infrastructure interaction

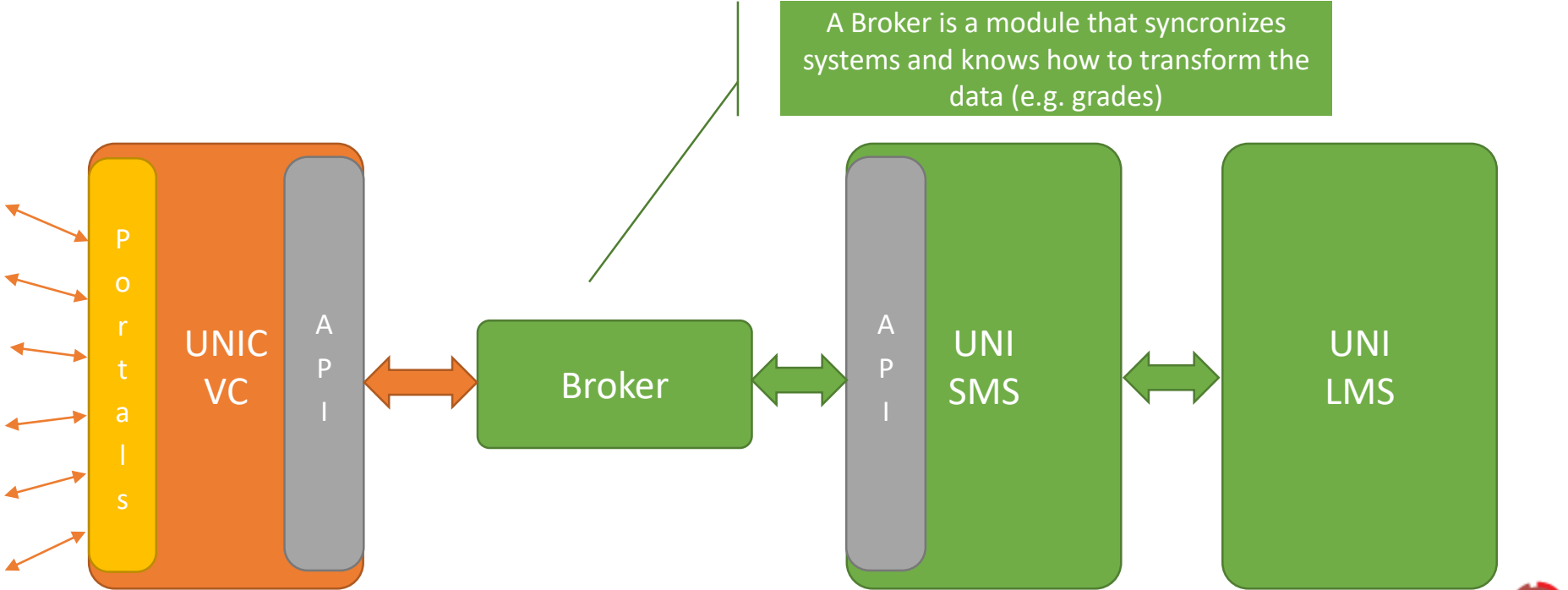

# VC – UNI infrastructure interaction

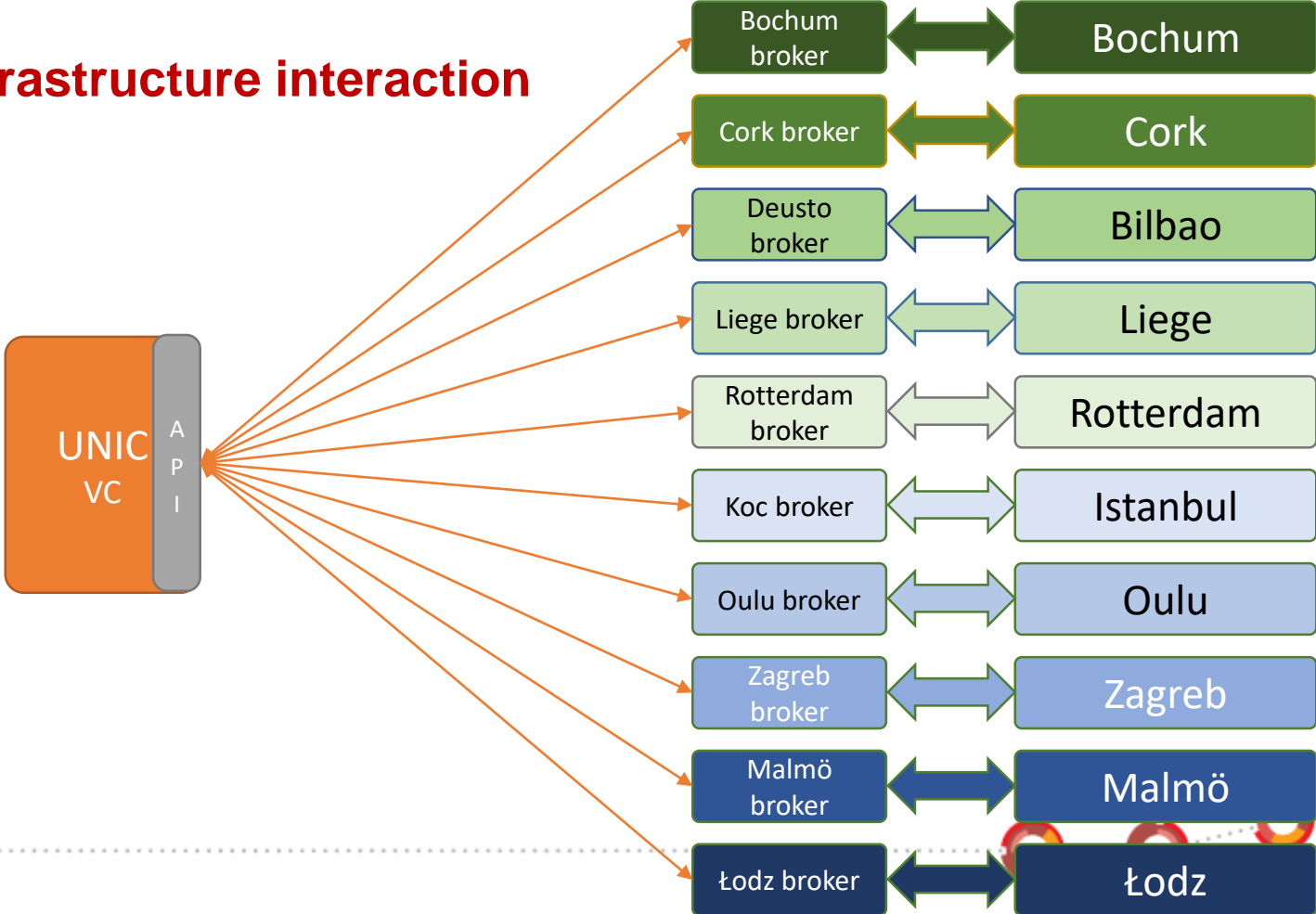

# Local (University level) Components

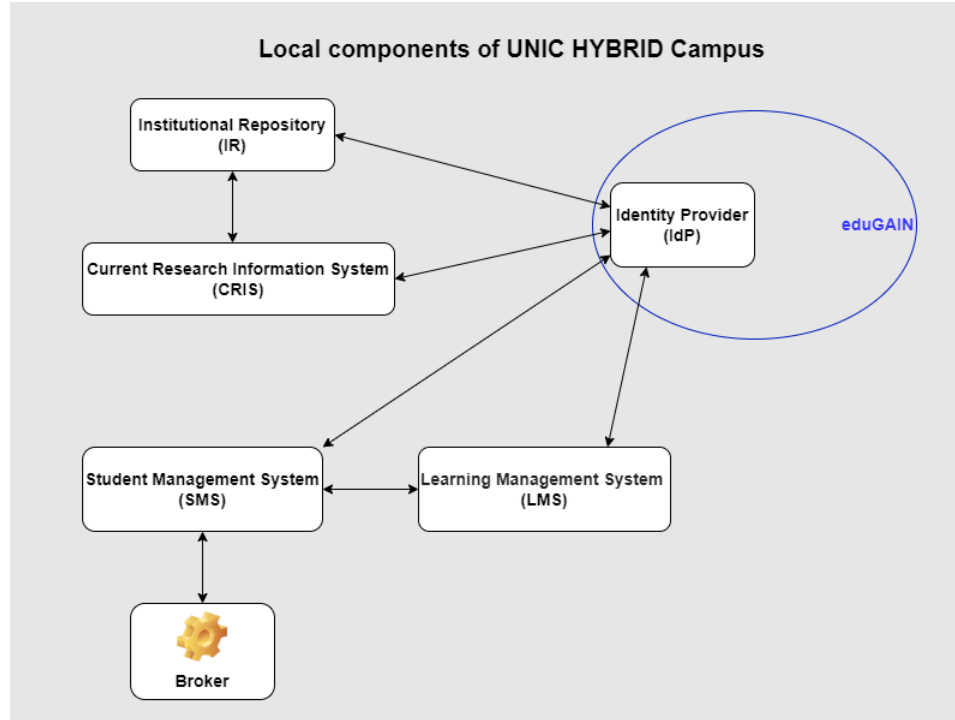



# VC – UNI infrastructure interaction

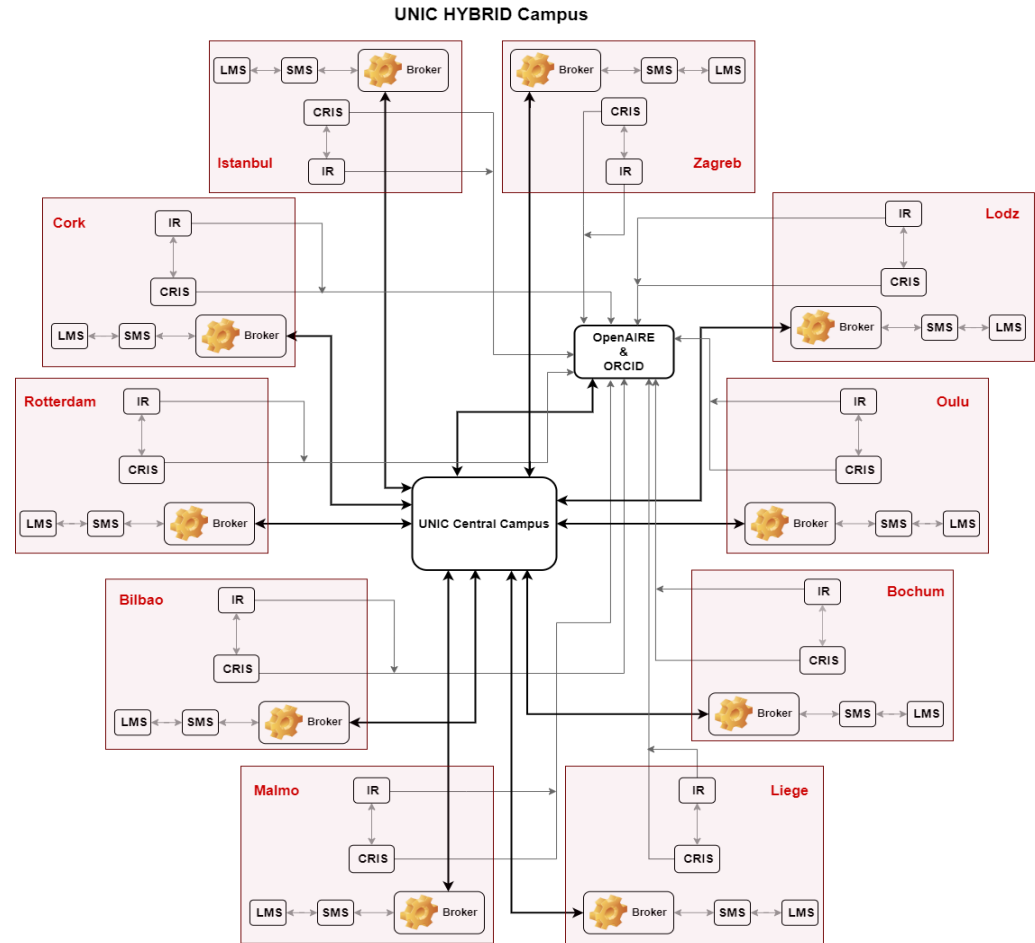

# User roles

- System administrators
- University administrators
- Organizational unit (faculty, department, ...) administrators
- Students
- Researchers



# Functionalities overview and Current status of UNIC VC



# Implemented functionalities

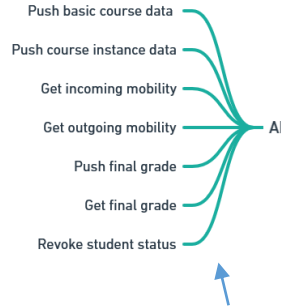

Extra API end-points for additional convenience

UNIC Virtual Campus

Available through APIs and web app

Protected (login via eduGAIN)

Public

- Browse currently offered courses
- Browse Joint programmes







## VC Supports...

- UNIC European Student Card
- Course catalogue
- Joint-8 programmes catalogue
- Virtual mobility – course selection, enrolment, grade exchange
- Open Science Campus (UNIC4ER)
- ...



## VC Supports...

- UNIC European Student Card 
- Course catalogue 
- Joint-8 programmes catalogue 
- Virtual mobility – course selection, enrolment, grade exchange 
- Open Science Campus (UNIC4ER) 
- ...

 = In development

 = In production



# UNIC European Student Card

- Virtual only
- Can be represented in digital form and carried in a mobile device
- Generated by, stored in and verified by UNIC VC
- Contains minimal set of data related to a student
- Can be revoked or reactivated at any time by an administrator
- Validated by scanning the code on the card



Europsko sveučilište  
postindustrijskih gradova

## UNIC EUROPSKA STUDENTSKA KARTICA

IME Ognjen Orel

SVEUČILIŠTE University of Zagreb



Skeniraj ovaj kod za validaciju

Za više informacija, posjetite [www.unic.eu](http://www.unic.eu)

# UNIC European Student Card



Ollscoil Eorpach na  
gCathracha Iarthionsclaíocha

## UNIC CÁRTA EORPACH NA nDALTAÍ

AINM Ognjen Orel

OLLSCOIL University of Zagreb



Scan an cód seo le bailíochtú

Le haghaidh tuilleadh eolais, tabhair cuairt ar [www.unic.eu](http://www.unic.eu)



European University of  
Post-Industrial Cities

## UNIC EUROPEAN STUDENT CARD

NAME Ognjen Orel

UNIVERSITY University of Zagreb



Scan this code to validate

For more information, visit [www.unic.eu](http://www.unic.eu)



Europsko sveučilište  
postindustrijskih gradova

## UNIC EUROPSKA STUDENTSKA KARTICA

IME Ognjen Orel

SVEUČILIŠTE University of Zagreb



Skeniraj ovaj kod za validaciju

Za više informacija, posjetite [www.unic.eu](http://www.unic.eu)



# Course catalogue

- A public list of courses offered by all universities
- Automated entry via APIs (or manual)
- Course data:
  - IDs
  - Name
  - Description
  - URI
  - ISCED code
  - Teachers
  - Prerequisites
  - Course instances and quotas



# Joint programmes catalogue

- A public list of programmes and their courses offered by UNIC
- Automated entry via APIs (or manual) of courses
- Manual entry of programmes and course addition
- Programme data:
  - ID
  - Name
  - Administrating university
  - List of courses



## Virtual mobility (happy path; example from Oulu to Zagreb)

- Student from Zagreb browses courses and enrolls in a one offered by Oulu
- Local administrator from Zagreb checks the prerequisites – approves it
- Local administrator from Oulu checks the student application – approves it
- Student's data is sent to Oulu SMS
- Student gets the admission to Oulu SMS & LMS
- Student gets the grade (in Oulu SMS), transferred to VC
- Student's grade is transferred from VC to Zagreb SMS

Within UNIC VC portal

Automated



# Current functionalities in the UNIC VC web applications





Home Courses Joint Programmes Help [Sign in](#)

## Virtual Campus

This portal gives an overview of all courses and joint programmes that are available through UNIC universities' study programs.  
For more information about UNIC visit [unic.eu](http://unic.eu).

[Courses](#) [Joint programmes](#)



[Accessibility statement](#)

Software support (c) and maintenance :: University of Zagreb University Computing Centre



## Courses



Name	Description	ECTS Credits	Organization name	University name	ISCED code (Broad field)	Details
<a href="#">Databases</a>	Description of Databases	5	Faculty of Mining, Geology and Petroleum Engineering	University of Zagreb	06 Information and Communication Technologies (ICTs)	<a href="#">+</a>
Differential Geometry	Description of Differential Geometry	5	Faculty of Mining, Geology and Petroleum Engineering	University of Zagreb	05 Natural sciences, mathematics and statistics	<a href="#">+</a>
Cadastr	Description of Cadastr	7	Faculty of Mining, Geology and Petroleum Engineering	University of Zagreb	07 Engineering, manufacturing and construction	<a href="#">+</a>
Geodetic Plans	Description of Geodetic Plans	5	Faculty of Mining, Geology and Petroleum Engineering	University of Zagreb	07 Engineering, manufacturing and construction	<a href="#">+</a>
Introduction into Information Society	Description of Introduction into Information Society	3	Faculty of Mining, Geology and Petroleum Engineering	University of Zagreb	03 Social sciences, journalism and information	<a href="#">+</a>
<a href="#">English in Geodesy</a>	Description of English in Geodesy	3	Faculty of Mining, Geology and Petroleum Engineering	University of Zagreb	02 Arts and humanities	<a href="#">+</a>
<a href="#">German in geodesy</a>	Description of German in geodesy	3	Faculty of Mining, Geology and Petroleum Engineering	University of Zagreb	02 Arts and humanities	<a href="#">+</a>
<a href="#">Topography</a>	Description of Topography	3	Faculty of Mining, Geology and Petroleum Engineering	University of Zagreb	05 Natural sciences, mathematics and statistics	<a href="#">+</a>
Cartography	Description of Cartography	5	Faculty of Mining, Geology and Petroleum Engineering	University of Zagreb	05 Natural sciences, mathematics and statistics	<a href="#">+</a>
<a href="#">Geodetic Reference Frames</a>	Description of Geodetic Reference Frames	5	Faculty of Mining, Geology and Petroleum Engineering	University of Zagreb	07 Engineering, manufacturing and construction	<a href="#">+</a>

# Course instance details (public)



Courses



Name	Description	(Broad field)	Details
Information Society	Description of Information Society	Information Society	+
Introduction to programming	Introduction to programming	Computer science and network design	+
Hydrographic Survey	Description of Hydrographic Survey	Hydrographic Survey and Communication (CTS)	+
Algorithms	Algorithms	Algorithms and applications and analysis	+
Selected Chapters in Higher Mathematics	Description of Selected Chapters in Higher Mathematics	Selected Chapters in Higher Mathematics	+
Databases	Description of Databases	Databases and Communication (CTS)	+
Mathematics 1	Mathematics 1	Mathematics	+
Object Oriented Programming	Object Oriented Programming	Object Oriented Programming	+

Course info - **Selected Chapters in Higher Mathematics (1004)**

**Prerequisites:**  
There are no prerequisites for this class.

**Instances:**

#	Academic Year	Period	Student quota	Teachers
1.	2022/2023	01 Dec 2022 - 28 Feb 2023	25	dr.sc. Andrija Andrić;
2.	2022/2023	01 Mar 2023 - 30 Jun 2023	25	Marija Novosel;

Rows per page: 10 ▾ 1-2 of 2 < >



# Joint Programmes (public)

Joint Programmes 





Programme name	Programme level	Administrative Organization name	Administrative University name	Partners	Courses
<a href="#">Sustainability in Agriculture, Food Production and Food Technology in the Danube Region - Danube AgriFood Master</a>	master	Faculty of Agriculture	University of Zagreb	Faculty of Organization and Informatics (Varaždin);	<a href="#">+</a>
<a href="#">Internet of Things</a>	bachelor	Faculty of Organization and Informatics	University of Zagreb	Faculty of Mining, Geology and Petroleum Engineering (Zagreb);	<a href="#">+</a>
<a href="#">Programming in C</a>	bachelor	Faculty of Organization and Informatics	University of Zagreb	Faculty of Electrical Engineering and Computing (Zagreb); Faculty of Mining, Geology and Petroleum Engineering (Zagreb); Ruhr University Bochum (Bochum);	<a href="#">+</a>
<a href="#">Programming in Java</a>	bachelor	Faculty of Organization and Informatics	University of Zagreb	Faculty of Economics and Business (Zagreb); Faculty of Croatian Studies (Zagreb);	<a href="#">+</a>

Rows per page: 10 ▾ 1-4 of 4 < >



# Joint Programme - Courses



UNIC

Joint Programmes

Programme name

Sustainability in Agriculture, Food and Nutrition Security - Danube AgriFood



Master in "Interdisciplinary Research in Food and Nutrition Security"

Joint International Postgraduate Program in Food and Nutrition Security

Human Rights, Society, and Multi-Sectoral Approaches

Sustainable Ship and Shipping 4.0

Intelligent Field Robotic Systems



Courses for Joint Programme - Sustainable Ship and Shipping 4.0 (5)

Name	Description	ECTS	Prerequisites
Topography	Description of Topography	3	There are no prerequisites for this class.
English I	Description of English I	1	There are no prerequisites for this class.
Physics of Medical Diagnostics	Description of Physics of Medical Diagnostics	0	There are no prerequisites for this class.
Internal Medicine	Description of Internal Medicine	23	There are no prerequisites for this class.
School Medicine	Description of School Medicine	1	There are no prerequisites for this class.
Cardiac Imaging	Description of Cardiac Imaging	1	There are no prerequisites for this class.
Elective: Hand Surgery	Description of Elective: Hand Surgery	4.5	There are no prerequisites for this class.

Sign in

Administrative University name

Courses

University of Zagreb (+)

University of Zagreb (+)



University of Zagreb (+)

University of Zagreb (+)

University of Zagreb (+)

University of Zagreb (+)

10 1-6 of 6 < >



# Home page

## Virtual Campus

This portal gives an overview of all courses and joint programmes that are available through UNIC universities' study programs. For more information about UNIC visit [unic.eu](http://unic.eu).

- [Courses](#)
- [Joint programmes](#)



# Sign in



AAI@EduHr

eduGAIN

Incremental search...

Erasmus University Rotterdam
Liege University - (ULiege / ULg)
Malmö University
Ruhr-Universität Bochum
Universidad de Deusto
University College Cork
University of Lodz
University of Oulu

eduGain  
providers



# Sign in



Login to SRCE eduGAIN proxy  
SP, edugainproxy.srce.hr

**Username**

**Password**

Login

> [Forgot your password?](#)

> [Sidan på svenska](#)

 **AA@EduHr** eduGAIN  
proxy for all the services provided by  
University of Zagreb, University Computing  
Centre (SRCE)



# Sign in



AAI@EduHr eduGAIN

AAI@EduHr Single Sign-On Service



Authentication and Authorisation Infrastructure of  
Science and Higher Education in Republic of Croatia

USERNAME

PASSWORD

**LOGIN**

[Help](#)

Srcce v3.0



# Registration form (first time sign in) – student



## Registration

Registration for bernard.crnkovic@fer.hr

### Basic information

\* - required field

Name\*

Bernard

Surname\*

Crnković

Title before name

Title after name

Email\*

bernard.crnkovic@fer.hr

Organization unit\*

Faculty of Electrical Engineering and Computing

Role\*

Student

Save



# Registration form (first time sign in) – admin



## Registration

Registration for dmilos@srce.hr

### Basic information

\* - required field

Name\*

Surname\*

Title before name

Title after name

Email\*

Organization unit\*

Role\*

[Save](#)



# Student portal



UNIC

Sign in

## Virtual Campus for Students

ALEN NOVOSEL  
alen.novosel@srce.hr

- HOME
- MY STUDENT CARD
- MY COURSES
  - Enrol in a course
  - Active courses
  - Pending enrolment
  - Course history

Welcome to Virtual Campus

Through this virtual campus you can enrol in various courses and activate/view your UNIC Student Card.

[Enrolment →](#) [Student card](#)

After, you can use this site to monitor your active courses or to browse through your course history.

[Active Courses](#) [Course history](#)





# Generate the Student Card



## Virtual Campus - Students

ALLEN NOVOSEL

Faculty of Organization and Informatics

- HOME
- MY STUDENT CARD
- MY COURSES
  - Enrol in a course
  - Pending enrolment
  - Active courses
  - Course history

Card status: **NOT GENERATED**

Generate your virtual UNIC student card here to be able to show that you are a UNIC student.

Croatian

- Basque
- Croatian
- Dutch
- English
- Finnish
- French
- German
- Irish
- Polish
- Spanish
- Swedish
- Turkish

Generate



# Download the Student Card



Sign out

## Virtual Campus - Students

ALLEN NOVOSEL  
Faculty of Organization and Informatics

- HOME
- MY STUDENT CARD
- MY COURSES
  - Enrol in a course
  - Pending enrolment
  - Active courses
  - Course history

Card status: **ACTIVE**

If you have active card status you can download your virtual student card here.  
If your card is not active, and you want to activate it, contact your home university's administrator.

Generated date: 03 Nov 2022  
Deactivated date: -

English

Download



studentCard (22).png

Show all

# My Student Card



UNIC

European University of  
Post-Industrial Cities

## UNIC EUROPEAN STUDENT CARD

NAME Alen Novosel

UNIVERSITY University of Zagreb



Scan this code to validate

For more information, visit [www.unic.eu](http://www.unic.eu)

Validation is done by scanning the QR code. That opens the browser with the application that checks the card validity.



# Course enrolment

Home Courses Joint Programmes Student Help Sign out

## Virtual Campus - Students

ALLEN NOVOSEL  
Faculty of Organization and Informatics

- HOME
- MY STUDENT CARD
- MY COURSES
  - Enrol in a course
  - Pending enrolment
  - Active courses
  - Course history

### Courses available for enrolment

Name	ECTS Credits	Start Date	End Date	Teachers	Mode of attendance	Action	Organization name	University name
<a href="#">Information Society</a>	3	01 Mar 2023	01 Jun 2023		Choose	Apply	Faculty of Geodesy	University of Zagreb
Introduction to programming	1	01 Mar 2023	30 Jun 2023	dr.sc. Marija Nose;	Choose	Apply		Ruhr University Bochum
<a href="#">Databases</a>	5	01 Mar 2023	30 Jun 2023		Choose	Apply	Faculty of Electrical Engineering and Computing	University of Zagreb
Mathematics 1	5	01 Feb 2023	31 May 2023		Choose	Apply	Faculty of Electrical Engineering and Computing	University of Zagreb
Object Oriented Programming	5	28 Feb 2023	19 Jul 2023		Virtual	Apply	Faculty of Electrical Engineering and Computing	University of Zagreb

Items per page: 10 1-5 of 5



# Pending enrolment



Sign out

## Virtual Campus - Students

ALEN NOVOSEL  
Faculty of Organization and Informatics

- HOME
- MY STUDENT CARD
- MY COURSES
  - Enrol in a course
  - Pending enrolment
  - Active courses
  - Course history

### Pending enrolment

Name	ECTS Credits	Start Date	End Date	Mode of attendance	Status ID	Status	Action	Organization name	University name
Object Oriented Programming	5	28 Feb 2023	19 Jul 2023	Virtual	1	applied	<a href="#">Cancel</a>	Faculty of Electrical Engineering and Computing	University of Zagreb

Rows per page: 10 1-1 of 1



# Active courses

## Virtual Campus - Students

ALLEN NOVOSEL  
Faculty of Organization and Informatics

- HOME
- MY STUDENT CARD
- MY COURSES
  - Enrol in a course
  - Pending enrolment
  - Active courses
  - Course history

### Active courses

Name	ECTS Credits	Academic Year	Start Date	End Date	Mode of attendance	Organization name	University name
Object Oriented Programming	5	2022/2023	28 Feb 2023	19 Jul 2023	Virtual	Faculty of Electrical Engineering and Computing	University of Zagreb

Rows per page: 10 1-1 of 1

# Course history – Finished courses



Sign out

## Virtual Campus - Students

ALEN NOVOSEL  
Faculty of Organization and Informatics

- HOME
- MY STUDENT CARD
- MY COURSES
  - Enrol in a course
  - Pending enrolment
  - Active courses
  - Course history

### Course history

Finished courses Courses status

Name	ECTS Credits	Academic Year	Start Date	End Date	Mode of attendance	Grade	Organization name	University name
Introduction to programming	1	2022/2023	01 Dec 2022	28 Feb 2023	Virtual	Very Good (B)		Ruhr University Bochum

Rows per page: 10 1-1 of 1



# Course history – Unfinished courses

- HOME
- MY STUDENT CARD
- MY COURSES
  - Enrol in a course
  - Pending enrolment
  - Active courses
  - Course history

### Course history

Finished courses Courses status

Name	ECTS Credits	Academic Year	Start Date	End Date	Mode of attendance	Status ID	Status	Organization name	University name
German I	1	2022/2023	01 Dec 2022	28 Feb 2023	Virtual	6	dropped off	Faculty of Croatian Studies	University of Zagreb
Introduction to Medicine and Social Medicine	8	2022/2023	01 Dec 2022	28 Feb 2023	Physical	2	home UNI approved	School of Dental Medicine	University of Zagreb

Rows per page: 10 1-2 of 2





## Virtual Campus - Administrator

 ALEN NOVOSEL  
University of Zagreb

### HOME

#### PERSON

[Pending registrations \(14\)](#)  
[User management](#)  
[Teacher management](#)

#### STUDENTS

[Cards](#)  
[Outgoing pending enrolment \(1\)](#)  
[Outgoing active](#)  
[Outgoing finished](#)  
[Outgoing history](#)

#### COURSES

[Course management](#)  
[Incoming pending enrolment \(1\)](#)  
[Incoming active \(4\)](#)  
[Incoming finished](#)  
[Incoming history](#)

#### JOINT PROGRAMMES

[My programmes \(Administering\)](#)  
[Partner programmes \(Participating\)](#)

### Welcome to Virtual Campus

This virtual campus allows administrators to approve pending staff/student registrations for their organization unit. Also, it allows them to add/edit new courses, course instances and joint programmes.

Through this portal administrators can browse generated UNIC student cards for their organization unit and activate/deactivate them.

Other than that, this portal allows mobility management. Outgoing mobility gives an overview of students who applied for student exchange, while incoming mobility gives an overview of all courses that have at least one applicant. Student requests can either be approved or denied by home or receiving university administrator. Mobility management gives a detailed overview of all applicants in different enrolment stages (statuses).



# Person – Pending registrations (Staff)

Home Courses Joint Programmes Administrator HelpSign out

## Virtual Campus - Administrator



ALEN NOVOSEL  
University of Zagreb

- HOME
- PERSON
  - Pending registrations (14)**
  - User management
  - Teacher management
- STUDENTS
  - Cards
  - Outgoing pending enrolment (1)
  - Outgoing active
  - Outgoing finished
  - Outgoing history
- COURSES
  - Course management
  - Incoming pending enrolment (1)
  - Incoming active (4)
  - Incoming finished
  - Incoming history
- JOINT PROGRAMMES
  - My programmes (Adminstrating)
  - Partner programmes (Participating)

### Pending registrations

Staff (13) Students (1)

#	First name	Last name	eMail	Role	ESI	Actions	Organization name
1.	Džemal	Kvorka	yagodzinskayairina@fpfc.cf	Organizational Unit Admin (OrgUnit Admin)		<a href="#">Edit</a> <input checked="" type="checkbox"/>	Faculty of Organization and Informatics
2.	Paval	Mračić	booba@mumbama.com	Organizational Unit Admin (OrgUnit Admin)		<a href="#">Edit</a> <input checked="" type="checkbox"/>	Faculty of Geodesy
3.	Sibila	Puškarović	ajackson2385@easygd.com	Organizational Unit Admin (OrgUnit Admin)		<a href="#">Edit</a> <input checked="" type="checkbox"/>	Faculty of Electrical Engineering and Computing
4.	Martino	Cukor	f70vjbo@king.buzz	Organizational Unit Admin (OrgUnit Admin)		<a href="#">Edit</a> <input checked="" type="checkbox"/>	Faculty of Science
5.	Mane	Žičmanović	elfeeko@oanghika.com	Organizational Unit Admin (OrgUnit Admin)		<a href="#">Edit</a> <input checked="" type="checkbox"/>	Faculty of Veterinary Medicine
6.	Andy	Klapač	buddy84@dmxs8.com	Organizational Unit Admin (OrgUnit Admin)		<a href="#">Edit</a> <input checked="" type="checkbox"/>	Faculty of Food Technology and Biotechnology
7.	Radenko	Jerličević	lukovski@gmailwe.com	Organizational Unit Admin (OrgUnit Admin)		<a href="#">Edit</a> <input checked="" type="checkbox"/>	Faculty of Law



# Person – Pending registrations (Staff)

The screenshot shows the UNIC Virtual Campus Administrator interface. At the top, there is a navigation bar with links for Home, Courses, Joint Programmes, Administrator, and Help, along with a Sign out button. The main header displays 'Virtual Campus - Administrator' and the user's name 'ALEN NOVOSEL' from the University of Zagreb. A left sidebar contains a menu with categories: HOME, PERSON (with sub-items: Pending registrations (14), User management, Teacher management), STUDENTS (with sub-items: Cards, Outgoing pending enrolment (1), Outgoing active, Outgoing finished, Outgoing history), COURSES (with sub-items: Course management, Incoming pending enrolment (1), Incoming active (4), Incoming finished, Incoming history), and JOINT PROGRAMMES (with sub-items: My programmes (Administering), Partner programmes (Participating)).

A modal window titled 'Edit person information' is open in the center. It contains the following fields:

- \* - required field
- First name\*: Paval
- Last name\*: Mračić
- Title before name: (empty)
- Title after name: (empty)
- Email\*: pmracic@unizg.com

A red 'Save' button is located at the bottom of the modal. In the background, a table of pending registrations is visible, with columns for ESI, Actions, and Organization name. The table lists several entries, including Faculty of Organization and Informatics, Faculty of Geodesy, Faculty of Electrical Engineering and Computing, Faculty of Science, Faculty of Veterinary Medicine, Faculty of Food Technology and Biotechnology, and Faculty of Law.



# Person – Pending registrations (Students)



## Virtual Campus - Administrator

- HOME
- PERSON
  - Pending registrations (14)
  - User management
  - Teacher management
- STUDENTS
  - Cards
  - Outgoing pending enrolment (1)
  - Outgoing active
  - Outgoing finished
  - Outgoing history
- COURSES
  - Course management
  - Incoming pending enrolment (1)
  - Incoming active (4)
  - Incoming finished
  - Incoming history
- JOINT PROGRAMMES
  - My programmes (Administering)
  - Partner programmes (Participating)

### Pending registrations

Staff (13) Students (1)

#	First name	Last name	eMail	Actions	Organization name
1.	Bernard	Crnković	bernard.crnkovic@fer.hr	<a href="#">Confirm</a>	Faculty of Electrical Engineering and Computing

Confirm



Rows per page: 10 1-1 of 1



# Person – User management (activate/deactivate profile)



## Virtual Campus - Administrator

- HOME
- PERSON
  - Pending registrations (14)
  - User management
  - Teacher management
- STUDENTS
  - Cards
  - Outgoing pending enrolment (1)
  - Outgoing active
  - Outgoing finished
  - Outgoing history
- COURSES
  - Course management
  - Incoming pending enrolment (1)
  - Incoming active (4)
  - Incoming finished
  - Incoming history
- JOINT PROGRAMMES
  - My programmes (Adminstrating)
  - Partner programmes (Participating)

### User management

Staff Students

Title before name	First name	Last name	Title after name	eMail	Role	Actions
	Antoana	Moravski		sucawilton@alvinneo.com	University Admin (UNI Admin)	
	Selma	Kozmić		cloudr4@netmon.hr	Organizational Unit Admin (OrgUnit Admin)	
	Rujana	Genzić		gramtan@laudmed.com	Organizational Unit Admin (OrgUnit Admin)	
	Bore	Malounek		itacorsps@mailpluss.com	Organizational Unit Admin (OrgUnit Admin)	
	Sibila	Puškarović		ajackson2385@easygbd.com	Organizational Unit Admin (OrgUnit Admin)	
	Martino	Čukor		f70vjbo@king_buzz	Organizational Unit Admin (OrgUnit Admin)	
	Mane	Žičmanović		elfeeko@oanghika.com	Organizational Unit Admin (OrgUnit Admin)	
	Matan	Čargonja		mihalus@shotshe.com	Organizational Unit Admin (OrgUnit Admin)	
	Andy	Klapac		buddy84@dmxs8.com	Organizational Unit Admin (OrgUnit Admin)	

Deactivate profile



# Person – Teacher management



## Virtual Campus - Administrator

- HOME
- PERSON
  - Pending registrations (14)
  - User management
  - Teacher management
- STUDENTS
  - Cards
  - Outgoing pending enrolment (1)
  - Outgoing active
  - Outgoing finished
  - Outgoing history
- COURSES
  - Course management
  - Incoming pending enrolment (1)
  - Incoming active (4)
  - Incoming finished
  - Incoming history
- JOINT PROGRAMMES
  - My programmes (Adminstrating)
  - Partner programmes (Participating)

### Teacher management

Add teacher



Title before name	First name	Last name	Title after name	eMail	ORCID ID	Actions
dr.sc.	Andrija	Andrić		kallzhnikova@omdlaco.com		
	Marija	Novosel		m@mcom	0000-0003-2247-3477	
	Ognjen	Orel		ab@bcm	0000-0001-8903-6605	
dr.sc.	Paval	Mračić		booba@mumbama.com		
	Pero	Perić		pero@email.com		

Rows per page: 10 1-5 of 5



# Person – Teacher management (Add teacher)

The screenshot shows the 'Add teacher' form in the UNIC Virtual Campus Administrator. The form is a white modal window with a close button (X) in the top right corner. It contains the following fields and elements:

- \* - required field**
- First name\***: Input field containing 'Alen'.
- Last name\***: Input field containing 'Novosel'.
- Title before name**: Empty input field.
- Title after name**: Empty input field.
- Email**: Input field containing 'anovosel@foi.hr'.
- Search ORCID**: A blue button.
- ORCID\***: A dropdown menu showing 'Alen Novosel [ORCID: 0000-0001-7037-1323], [email: alen.novosel@srce.hr]'.
- Save**: A red button at the bottom left, highlighted with a large orange arrow.

The background shows the 'Virtual Campus - Administrator' interface with a dark sidebar on the left containing navigation menus for HOME, PERSON, STUDENTS, COURSES, and JOINT PROGRAMMES. The top navigation bar includes 'Home', 'Courses', 'Joint Programmes', 'Administrator', and 'Help', along with a 'Sign out' button. The user 'ALEN NOVOSEL' is logged in from the University of Zagreb.



# Course management



## Virtual Campus - Administrator

HOME

PERSON

- Pending staff registrations
- Pending student registrations

STUDENTS

- Cards
- Outgoing pending enrolment
- Outgoing active
- Outgoing finished
- Outgoing history

COURSES

- Course management
- Incoming pending enrolment
- Incoming active
- Incoming finished
- Incoming history

JOINT PROGRAMMES

### Courses



Local course ID	Name	Description	ECTS Credits	Prerequisites	Active	Actions	Course instances
27393	Selected Chapters in Higher Mathematics	Selected Chapters in Higher Mathematics	7	There are no prerequisites for this class.	Active		
32888	<a href="#">Hydrographic Survey</a>	Description of Hydrographic Survey	5	There are no prerequisites for this class.	Active		
33497	<a href="#">Programming</a>	Description of Programming	5	There are no prerequisites for this class.	Active		
50422	Programming In Geoinformation Systems	Description of Programming In Geoinformation Systems	6	There are no prerequisites for this class.	Active		
72614	Algorithms	Algorithms	6	There are no prerequisites for this class.	Active		

Rows per page: 10 1-5 of 5 < >





# Course management – add new

The screenshot shows the 'Add new course' form in the UNIC Virtual Campus interface. The form is a white modal window with a close button in the top right corner. It contains the following fields and options:

- Course name\***: Text input field containing "Selected Chapters in Higher Mathematics".
- Course description\***: Text input field containing "Selected Chapters in Higher Mathematics".
- Course prerequisites**: Text input field containing "There are no prerequisites for this class."
- Course URI**: Empty text input field.
- ECTS credits\***: Text input field containing "7".
- Local course ID\***: Text input field containing "27393".
- Active\***: Dropdown menu with "Active" selected.
- ISCED code\***: Dropdown menu with "[0541] Mathematics" selected.

A red "Save" button is located at the bottom left of the form, with a large orange arrow pointing to it. The background shows the UNIC Virtual Campus navigation menu and a user profile for ALEN NOVOSEL.



# Course management – Course instances



Sign out

## Virtual Campus - Administrator

ALEN NOVOSEL  
University of Zagreb

- HOME
- PERSON
  - Pending registrations (14)
  - User management
  - Teacher management
- STUDENTS
  - Cards
  - Outgoing pending enrolment (1)
  - Outgoing active
  - Outgoing finished
  - Outgoing history
- COURSES
  - Course management**
  - Incoming pending enrolment (1)
  - Incoming active (4)
  - Incoming finished
  - Incoming history
- JOINT PROGRAMMES
  - My programmes (Administering)
  - Partner programmes (Participating)

### Courses

Add course

sele

Local course ID	Name	Description	ECTS Credits	Prerequisites	Active	Actions	Course instances
50414	Selected Chapters of Photogrammetry and GIS	Description of Selected Chapters of Photogrammetry and GIS	6	There are no prerequisites for this class.	Active		
27393	Selected Chapters in Higher Mathematics	Selected Chapters in Higher Mathematics	7	There are no prerequisites for this class.	Active		

Rows per page: 10 1-2 of 2



# Course instances



## Virtual Campus - Administrator

- HOME
- PERSON
  - Pending registrations (14)
  - User management
  - Teacher management
- STUDENTS
  - Cards
  - Outgoing pending enrolment (1)
  - Outgoing active
  - Outgoing finished
  - Outgoing history
- COURSES
  - Course management
  - Incoming pending enrolment (1)
  - Incoming active (4)
  - Incoming finished
  - Incoming history
- JOINT PROGRAMMES
  - My programmes (Adminstrating)
  - Partner programmes (Participating)

### < Selected Chapters in Higher Mathematics (27393) Course instances

**New instance**

Active instances Instances history

Instance number	Academic year	Start date	End date	Quota	Actions	Teachers
273931	2022/2023	01 Dec 2022	28 Feb 2023	25		dr.sc. Andrija Andrić;
123345	2022/2023	01 Mar 2023	30 Jun 2023	25		Marija Novosel;

Rows per page: 10 1-2 of 2 < >



# Course instances – add new



The screenshot shows the UNIC Virtual Campus Administrator interface. At the top, there is a navigation bar with 'Home', 'Courses', 'Joint Programmes', and 'Administrator' links, and a 'Sign out' button. The main header displays 'Virtual Campus - Administrator' and the user's name 'ALEN NOVOSEL' from the 'Faculty of Organization and Informatics'. A sidebar on the left lists various menu items under categories like 'PERSON', 'STUDENTS', 'COURSES', and 'JOINT PROGRAMMES'. The central focus is a modal window titled 'Selected Chapters in Higher Mathematics (27393)' with a close button. Inside the modal, the text 'Add new course instance' is displayed. Below this, a legend indicates that an asterisk (\*) denotes a required field. The form contains five input fields: 'Course instance number\*' (with value 273931), 'Academic year\*' (with value 2022), 'Start date\*' (with value 01/12/2022 and a calendar icon), 'End date\*' (with value 28/02/2023 and a calendar icon), and 'Quota\*' (with value 25). A red 'Save' button is located at the bottom of the form. The background of the interface is dimmed, showing a table with columns for 'Actions' and 'Teachers'.



# Course instance – add teacher

The screenshot shows the UNIC Virtual Campus Administrator interface. The top navigation bar includes 'Home', 'Courses', 'Joint Programmes', and 'Administrator', along with a 'Sign out' button. The main header displays 'Virtual Campus - Administrator' and the user's name 'ALEN NOVOSEL' from the 'Faculty of Organization and Informatics'. A left sidebar contains a menu with categories: HOME, PERSON (Pending staff registrations, Pending student registrations), STUDENTS (Cards, Outgoing pending enrolment, Outgoing active, Outgoing finished, Outgoing history), COURSES (Course management, Incoming pending enrolment, Incoming active, Incoming finished, Incoming history), and JOINT PROGRAMMES.

The main content area is titled 'Selected Chapters in Higher Mathematics (27393)' and 'Course instances'. It features a 'New instance' button and two tabs: 'Active instances' (selected) and 'Instances history'. A table displays the following data:

Instance number	Academic year	Start date	End date	Quota	Actions	Teachers
273931	2022	01 Dec 2022	28 Feb 2023	25		

Below the table, it indicates 'Rows per page: 10'. A red arrow points to the 'Add teacher' icon in the Actions column.



# Course instance – add teacher

UNIC

Home Courses Joint Programmes Administrator Help

Virtual Campus - Administrator

Sign out

ALEN NOVOSEL  
University of Zagreb

HOME

PERSON

Pending registrations (14)

User management

Teacher management

STUDENTS

Cards

Outgoing pending enrolment (1)

Outgoing active

Outgoing finished

Outgoing history

COURSES

Course management

Incoming pending enrolment (1)

Incoming active (4)

Incoming finished

Incoming history

JOINT PROGRAMMES

My programmes (Adminstrating)

Partner programmes (Participating)

Selected Chapters in Higher Mathematics (27393)

Manage teachers - Course instance (273931)

\* - required field

Teacher\*  Role\*

Marija Novosel

Ognjen Orel

Paval Mračić

Pero Perić

name	name	Last name	Title after name	Role	Action
dr.sc.	Andrija	Andrić		Main teacher	

Rows per page: 10 1-1 of 1

Rows per page: 10 1-2 of 2

# Joint programmes – administration



## Virtual Campus - Administrator

- HOME
- PERSON
  - Pending registrations (1)
  - User management
  - Teacher management
- STUDENTS
  - Cards
  - Outgoing pending enrolment (1)
  - Outgoing active
  - Outgoing finished
  - Outgoing history
- COURSES
  - Course management
  - Incoming pending enrolment (0)
  - Incoming active (1)
  - Incoming finished
  - Incoming history
- JOINT PROGRAMMES
  - My programmes (Adminstrating)
  - Partner programmes (Participating)

### My programmes

Add joint programme



Programme name	Programme level	Partner institutions	Courses	Actions
<a href="#">Internet of Things</a>	bachelor	Faculty of Mining, Geology and Petroleum Engineering;	Analytical Geometry and Linear Algebra; 4D-Geodesy;	<a href="#">edit</a> <a href="#">home</a> <a href="#">copy</a>
<a href="#">Programming in C</a>	bachelor	Faculty of Electrical Engineering and Computing; Faculty of Mining, Geology and Petroleum Engineering; Ruhr University Bochum;	Databases; How Marketing Operates ? Its Tools and Techniques; Introduction to programming; Algorithms; Selected Chapters in Higher Mathematics;	<a href="#">edit</a> <a href="#">home</a> <a href="#">copy</a>
<a href="#">Programming in Java</a>	bachelor	Faculty of Economics and Business; Faculty of Croatian Studies;	Hydrographic Survey; Programming; Programming in Geoinformation Systems;	<a href="#">edit</a> <a href="#">home</a> <a href="#">copy</a>

Rows per page: 10 1-3 of 3



# Joint programmes – add new

The screenshot displays the UNIC Virtual Campus Administrator interface. At the top, there is a navigation bar with links for Home, Courses, Joint Programmes, Administrator, and Help, along with a Sign out button. The user is identified as ALEN NOVOSEL, Faculty of Organization and Informatics. A modal window titled 'Add new joint programme' is open in the center, containing the following form fields:

- Programme name\***: A text input field containing 'Artificial Intelligence'.
- Programme level\***: A dropdown menu set to 'master'.
- URL**: A text input field containing 'https://example.com'.
- Partners\***: A multi-select dropdown menu with three selected items: 'Faculty of Electrical Engineering and Computing [Zagreb]', 'Faculty of Science [Zagreb]', and 'Faculty of Mechanical Engineering and Naval Architecture [Zagreb]'.

A red 'Save' button is located at the bottom of the modal, with a large orange arrow pointing to it. The background interface shows a sidebar menu with categories like HOME, PERSON, STUDENTS, COURSES, and JOINT PROGRAMMES, and a main content area with a table of items.



# Joint programmes – add new

The screenshot displays the 'Add new joint programme' form within the UNIC Virtual Campus Administrator interface. The form is a white modal window with a close button (X) in the top right corner. It contains the following fields and options:

- Programme name\***: A text input field containing 'Artificial Intelligence'.
- Programme level\***: A dropdown menu with 'master' selected.
- URL**: A text input field containing 'https://example.com'.
- Partners\***: A multi-select dropdown menu with three items: 'Faculty of Electrical Engineering and Computing [Zagreb]', 'Faculty of Science [Zagreb]', and 'Faculty of Mechanical Engineering and Naval Architecture [Zagreb]'. Each item has a small 'x' icon to its right.
- Save**: A red button located below the Partners field.
- Courses\***: A multi-select dropdown menu with four items: 'Algorithms [Faculty of Organization and Informatics]', 'Databases [Faculty of Electrical Engineering and Computing]', 'Programming [Faculty of Organization and Informatics]', and 'Mathematics 1 [Faculty of Electrical Engineering and Computing]'. Each item has a small 'x' icon to its right.
- Add courses**: A red button at the bottom of the form, highlighted by a large orange arrow.

The background interface shows the UNIC logo, the title 'Virtual Campus - Administrator', and a sidebar with navigation options like HOME, PERSON, STUDENTS, COURSES, and JOINT PROGRAMMES. The top right corner has a 'Sign out' button and the user's name 'ALEN NOVOSEL' and faculty 'Faculty of Organization and Informatics'. A table of courses is partially visible on the right side of the background.

# Joint programmes – edit partners



## Virtual Campus - Administrator

### HOME

### PERSON

- Pending registrations (1)
- User management
- Teacher management

### STUDENTS

- Cards
- Outgoing pending enrolment (1)
- Outgoing active
- Outgoing finished
- Outgoing history

### COURSES

- Course management
- Incoming pending enrolment (0)
- Incoming active (1)
- Incoming finished
- Incoming history

### JOINT PROGRAMMES

- My programmes (Adminstrating)
- Partner programmes (Participating)

### My programmes

Add joint programme

Programme name	Programme level	Partner institutions	Courses	Actions
Artificial Intelligence	master	Faculty of Electrical Engineering and Computing; Faculty of Science; Faculty of Mechanical Engineering and Naval Architecture;	Databases; Programming; Algorithms; Mathematics 1;	
Internet of Things	bachelor	Faculty of Mining, Geology and Petroleum Engineering;	Analytical Geometry and Linear Algebra; 4D-Geodesy;	
Programming in C	bachelor	Faculty of Electrical Engineering and Computing; Faculty of Mining, Geology and Petroleum Engineering; Ruhr University Bochum;	Databases; How Marketing Operates ? Its Tools and Techniques; Introduction to programming; Algorithms; Selected Chapters in Higher Mathematics;	 Edit partners
Programming in Java	bachelor	Faculty of Economics and Business; Faculty of Croatian Studies;	Hydrographic Survey; Programming; Programming in Geoinformation Systems;	



# Joint programmes – edit partners

The screenshot shows the UNIC Virtual Campus Administrator interface. At the top, there is a navigation bar with 'Home', 'Courses', 'Joint Programmes', 'Administrator', and 'Help'. A 'Sign out' button is in the top right. The user is identified as 'ALEN NOVOSEL' from the 'Faculty of Organization and Informatics'. The main content area is titled 'Virtual Campus - Administrator'. A sidebar on the left contains navigation links for 'HOME', 'PERSON', 'STUDENTS', 'COURSES', and 'JOINT PROGRAMMES'. The 'JOINT PROGRAMMES' section is active, showing 'My programmes (Administering)' and 'Partner programmes (Participating)'. A modal window titled 'Edit partners - Programming in Java' is open. It features a search input for 'Partner institution' with the value 'ru'. A dropdown menu below the input shows 'Ruhr University Bochum [Bochum]'. To the right of the input is a red 'Add partner' button, which is highlighted by an orange arrow. Below the search is a table of existing partner institutions:

Partner institution	Location	Action
Faculty of Croatian Studies	Zagreb	
Faculty of Economics and Business	Zagreb	

At the bottom of the table, it says 'Rows per page: 10' and '1-2 of 2'. The background shows a list of joint programmes, including 'Programming in Java'.



# Joint programmes – edit courses



## Virtual Campus - Administrator

- HOME
- PERSON
  - Pending registrations (1)
  - User management
  - Teacher management
- STUDENTS
  - Cards
  - Outgoing pending enrolment (1)
  - Outgoing active
  - Outgoing finished
  - Outgoing history
- COURSES
  - Course management
  - Incoming pending enrolment (0)
  - Incoming active (1)
  - Incoming finished
  - Incoming history
- JOINT PROGRAMMES
  - My programmes (Administering)
  - Partner programmes (Participating)

### My programmes

Add joint programme

Search, Refresh, Filter, Sort icons

Programme name	Programme level	Partner institutions	Courses	Actions
Artificial Intelligence	master	Faculty of Electrical Engineering and Computing; Faculty of Science; Faculty of Mechanical Engineering and Naval Architecture;	Databases; Programming; Algorithms; Mathematics 1;	<a href="#">Edit</a> <a href="#">Home</a> <a href="#">Print</a>
<a href="#">Internet of Things</a>	bachelor	Faculty of Mining, Geology and Petroleum Engineering;	Analytical Geometry and Linear Algebra; 4D-Geodesy;	<a href="#">Edit</a> <a href="#">Home</a> <a href="#">Print</a>
<a href="#">Programming in C</a>	bachelor	Faculty of Electrical Engineering and Computing; Faculty of Mining, Geology and Petroleum Engineering; Ruhr University Bochum;	Databases; How Marketing Operates ? Its Tools and Techniques; Introduction to programming; Algorithms; Selected Chapters in Higher Mathematics;	<a href="#">Edit</a> <a href="#">Home</a> <a href="#">Print</a>
Programming in Java	bachelor	Faculty of Economics and Business; Faculty of Croatian Studies;	Hydrographic Survey; Programming; Programming in Geoinformation Systems;	<a href="#">Edit</a> <a href="#">Home</a> <a href="#">Print</a>

Edit courses



# Joint programmes – edit courses

The screenshot displays the UNIC Virtual Campus Administrator interface. A modal window titled "Edit courses - Programming in Java" is open, showing a search for "Algorithms [Faculty of Organization and Informatics]". A red "Add course" button is highlighted with an orange arrow. Below the search is a table of existing courses.

Course	Organization unit	Action
Hydrographic Survey	Faculty of Organization and Informatics	
Programming	Faculty of Organization and Informatics	
Programming in Geoinformation Systems	Faculty of Organization and Informatics	

Rows per page: 10 | 1-3 of 3



# Joint programmes – participation



## Virtual Campus - Administrator

- HOME
- PERSON
  - Pending registrations (1)
  - User management
  - Teacher management
- STUDENTS
  - Cards
  - Outgoing pending enrolment (1)
  - Outgoing active
  - Outgoing finished
  - Outgoing history
- COURSES
  - Course management
  - Incoming pending enrolment (0)
  - Incoming active (1)
  - Incoming finished
  - Incoming history
- JOINT PROGRAMMES
  - My programmes (Administering)
  - Partner programmes (Participating)

### Partner programmes

Programme name	Programme level	Administrative organization	Administrative University name	Partners	Courses
Sustainability in Agriculture, Food Production and Food Technology in the Danube Region - Danube AgriFood Master <a href="#">↗</a>	master	Faculty of Agriculture	University of Zagreb	Faculty of Organization and Informatics;	<a href="#">+</a>

Rows per page: 10 ▾ 1-1 of 1 < >



# Joint programmes – participation

The screenshot shows the UNIC Virtual Campus Administrator interface. At the top, there is a navigation bar with links for Home, Courses, Joint Programmes, Administrator, and Help, along with a Sign out button. The main header area displays 'Virtual Campus - Administrator' and the user's name 'ALEN NOVOSEL' from the 'Faculty of Organization and Informatics'. A left sidebar contains a menu with categories like HOME, PERSON, STUDENTS, COURSES, and JOINT PROGRAMMES. A modal window is open in the center, titled 'Courses for Joint Programme - Sustainability in Agriculture, Food Production and Food Technology in the Danube Region - Danube AgriFood Master'. This modal contains a table with the following data:

Name	Description	ECTS	Prerequisites
Hydrographic Survey	Description of Hydrographic Survey	5	There are no prerequisites for this class.
Programming	Description of Programming	5	There are no prerequisites for this class.

Below the table, the modal shows 'Rows per page: 10' and '1-2 of 2' with navigation arrows. The background interface shows a table with columns for 'Administrative University name', 'Partners', and 'Courses', with a search bar and a plus icon for adding new entries.



# Student cards (activation/deactivation)



Sign out

## Virtual Campus - Administrator

ALEN NOVOSEL  
University of Zagreb

- HOME
- PERSON
  - Pending registrations (14)
  - User management
  - Teacher management
- STUDENTS
  - Cards
  - Outgoing pending enrolment (1)
  - Outgoing active
  - Outgoing finished
  - Outgoing history
- COURSES
  - Course management
  - Incoming pending enrolment (1)
  - Incoming active (4)
  - Incoming finished
  - Incoming history
- JOINT PROGRAMMES
  - My programmes (Administering)
  - Partner programmes (Participating)

### Student cards

ESI	First name	Last name	Generated	Deactivated	Action	Organization name	University name
HR-096404214-5711643253	Fatmir	Zahora	06 Sept 2022	22 Nov 2022	<a href="#">Activate</a>	Faculty of Geodesy	University of Zagreb
HR-068750569-0785636331	Krstina	Hadžar	01 Sept 2022	13 Nov 2022	<a href="#">Activate</a>	Faculty of Education and Rehabilitation Sciences	University of Zagreb
HR-653804258-670956274	Krstina	Zilic	03 Sept 2022	15 Oct 2022	<a href="#">Activate</a>	The Faculty of Political Science	University of Zagreb
HR-286067147-1181861841	Orijana	Brainović	04 Sept 2022	11 Oct 2022	<a href="#">Activate</a>	Faculty of Organization and Informatics	University of Zagreb
HR-308773236-8441407232	Andy	Leich	05 Sept 2022	-	<a href="#">Deactivate</a>	Faculty of Engineering, Geology and Petroleum	University of Zagreb
HR-894749158-7229435192	Soraja	Žkoprc	09 Sept 2022	-	<a href="#">Deactivate</a>	Faculty of Electrical Engineering and Computing	University of Zagreb
HR-995009155-5737051232	Aristea	Tapčanji	02 Sept 2022	17 Oct 2022	<a href="#">Activate</a>	Faculty of Science	University of Zagreb
HR-033683114-9217011851	Zuhra	Odžak	07 Sept 2022	06 Oct 2022	<a href="#">Activate</a>	Faculty of Veterinary Medicine	University of Zagreb

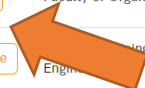



## Mobility – Course statuses

Id	Status name
1	Applied (Student)
2	Approved (home UNI)
3	Denied (home UNI)
4	Approved (receiving UNI)
5	Denied (receiving UNI)
6	Dropped off (Student)
7	Enrolled
8	Completed/Passed



# Outgoing Mobility – pending



Sign out

## Virtual Campus - Administrator

ALEN NOVOSEL  
Faculty of Organization and Informatics

- HOME
- PERSON
  - Pending registrations (1)
  - User management
  - Teacher management
- STUDENTS
  - Cards
  - Outgoing pending enrolment (1)
  - Outgoing active
  - Outgoing finished
  - Outgoing history
- COURSES
  - Course management
  - Incoming pending enrolment (0)
  - Incoming active (1)
  - Incoming finished
  - Incoming history
- JOINT PROGRAMMES
  - My programmes (Administrating)
  - Partner programmes (Participating)

### Outgoing pending enrolment

To do (1) Info

First name	Last name	eMail	ESI	Courses
Orljana	Brainović	riobraino@foi.hr	HR-286067147-1181861841	<a href="#">+</a>

Rows per page: 10 1-1 of 1



# Outgoing Mobility – pending

UNIC Home Courses Joint Programmes Administrator Help Sign out

Virtual Campus - Administrator ALEN NOVOSEL Faculty of Organization and Informatics

Outgoing pending enrolment

Approve/deny enrolment (Orijana Brainović)

Receiving university	Course	Academic year	ECTS	Start date	End date	Attendance	Status	Actions
Faculty of Electrical Engineering and Computing	Databases	2022/2023	5	01 Mar 2023	30 Jun 2023	Physical	1	<a href="#">Approve</a> <a href="#">Deny</a>

Rows per page: 10 1-1 of 1



# Outgoing Mobility – pending



### Outgoing pending enrolment

Info (Orijana Brainović)

Receiving university	Course	Academic year	ECTS	Start date	End date	Attendance	Status
Faculty of Electrical Engineering and Computing	Mathematics 1	2022/2023	5	01 Feb 2023	31 May 2023	Physical	2

Rows per page: 10 1-1 of 1



# Outgoing Mobility – active

- HOME
- PERSON
  - Pending registrations (1)
  - User management
  - Teacher management
- STUDENTS
  - Cards
  - Outgoing pending enrolment (1)
  - Outgoing active
  - Outgoing finished
  - Outgoing history
- COURSES
  - Course management
  - Incoming pending enrolment (0)
  - Incoming active (1)
  - Incoming finished
  - Incoming history
- JOINT PROGRAMMES
  - My programmes (Administering)
  - Partner programmes (Participating)

### Outgoing active students

First name	Last name	eMail	ESI	Courses
Daira	Nujic	dnujic@fol.hr	hr:0016501986	<a href="#">+</a>

Rows per page: 10 1-1 of 1



# Outgoing Mobility – active

UNIC Home Courses Joint Programmes Administrator Help Sign out

Virtual Campus - Administrator ALLEN NOVOSEL Faculty of Organization and Informatics

Outgoing active students

Active courses (Daira Nujic)

Receiving university	Course	Academic year	ECTS	Start date	End date	Enroled on	Attendance	Status
Faculty of Mining, Geology and Petroleum Engineering	Computer Geometry	2022/2023	5	01 Dec 2022	28 Feb 2023	14 Dec 2022, 10:11	Physical	7

Rows per page: 10 1-1 of 1



# Outgoing Mobility – finished

- HOME
- PERSON
  - Pending registrations (1)
  - User management
  - Teacher management
- STUDENTS
  - Cards
  - Outgoing pending enrolment (1)
  - Outgoing active
  - Outgoing finished
  - Outgoing history
- COURSES
  - Course management
  - Incoming pending enrolment (0)
  - Incoming active (1)
  - Incoming finished
  - Incoming history
- JOINT PROGRAMMES
  - My programmes (Administering)
  - Partner programmes (Participating)

### Outgoing finished

Course start date between:

Interval start: 24/01/2021 Interval end: 24/01/2023 Search

First Name	Last name	eMail	ESI	Courses
Alen	Novosel	alen.novosel@srce.hr	HR-976045666-3680156179	+ Inspect

Rows per page: 10



# Outgoing Mobility – finished

UNIC

Home Courses Joint Programmes Administrator Help

Sign out

Virtual Campus - Administrator

ALEN NOVOSEL  
Faculty of Organization and Informatics

Outgoing finished

Courses (Alen Novosel)

Receiving university	Course	Academic year	ECTS	Start date	End date	Enroled on	Attendance	Status	Grade	Grade date
Faculty of Mining, Geology and Petroleum Engineering	Topography	2022/2023	5	01 Oct 2022	28 Feb 2023	30 Aug 2022, 11:47	Virtual	8	A	30 Aug 2022

Rows per page: 10 1-1 of 1





# Outgoing Mobility – history



Sign out

## Virtual Campus - Administrator

ALEN NOVOSEL  
Faculty of Organization and Informatics

- HOME
- PERSON
  - Pending registrations (1)
  - User management
  - Teacher management
- STUDENTS
  - Cards
  - Outgoing pending enrolment (1)
  - Outgoing active
  - Outgoing finished
  - Outgoing history
- COURSES
  - Course management
  - Incoming pending enrolment (0)
  - Incoming active (1)
  - Incoming finished
  - Incoming history
- JOINT PROGRAMMES
  - My programmes (Adminstrating)
  - Partner programmes (Participating)

### Outgoing history

Course start date between:

Interval start  
24/01/2021

Interval end  
24/01/2023

Search

First name	Last name	eMail	ESI	Courses
Albina	Cvitečić	crazyroggy@janurganteng.com	HR-197497246-2607756699	+
Alen	Novosel	alen.novosel@srce.hr	HR-976045666-3680156179	+

Rows per page: 10 1-2 of 2



# Outgoing Mobility – history

UNIC Home Courses Joint Programmes Administrator Help Sign out

Virtual Campus - Administrator ALEN NOVOSEL Faculty of Organization and Informatics

Outgoing history

Courses history (Alen Novosel)

Receiving university	Course	Academic year	ECTS	Start date	End date	Attendance	Status
Faculty of Electrical Engineering and Computing	Databases	2022/2023	5	01 Dec 2022	28 Feb 2023	Physical	6
Faculty of Mining, Geology and Petroleum Engineering	Basics of German for Special Purposes	2021/2022	3	01 Mar 2022	10 Jun 2022	Virtual	5

Rows per page: 10 1-2 of 2



# Incoming Mobility – pending

UNIC

Home Courses Joint Programmes Administrator Help

Sign out

Virtual Campus - Administrator

ALEN NOVOSEL  
University of Zagreb

HOME Incoming pending enrolment

PERSONAL Pending User n Teach



STUDENT Cards Outgo Outgo Outgo

COURSES Courses Incom

Incoming active (4) Incoming finished Incoming history

JOINT PROGRAMMES My programmes (Adminstrating) Partner programmes (Participating)

Approve/deny enrolment (Mathematics 1)

Home university	First name	Last name	ESI	eMail	Attendance	Status	Actions
Faculty of Organization and Informatics	Orljana	Bralnović	HR-286067147-1181861841	riobrainlo@foi.hr	Physical	2	 

Rows per page: 10 1-1 of 1



# Incoming Mobility – active



Sign out

## Virtual Campus - Administrator

ALEN NOVOSEL  
University of Zagreb

- HOME
- PERSON
  - Pending registrations (14)
  - User management
  - Teacher management
- STUDENTS
  - Cards
  - Outgoing pending enrolment (1)
  - Outgoing active
  - Outgoing finished
  - Outgoing history
- COURSES
  - Course management
  - Incoming pending enrolment (1)
  - Incoming active (4)**
  - Incoming finished
  - Incoming history
- JOINT PROGRAMMES
  - My programmes (Administering)
  - Partner programmes (Participating)

### Incoming active

Local course ID	Course	Academic year	Start date	End date	ECTS	Students
32810	Geoinformation Quality	2021/2022	01 Oct 2021	28 Feb 2022	5	
32883	Land Information Systems	2021/2022	01 Mar 2022	10 Jun 2022	5	
33497	Programming	2022/2023	01 Oct 2022	31 Jan 2023	5	
33496	Computer Geometry	2022/2023	01 Dec 2022	28 Feb 2023	5	

Rows per page: 10 1-4 of 4



# Incoming Mobility – active (register grade)

UNIC

Home Courses Joint Programmes Administrator Help

Sign out

Virtual Campus - Administrator

ALEN NOVOSEL  
University of Zagreb

HOME Incoming active

Register grade (Programming)

Home university	First name	Last name	ESI	eMail	Enroled on	Attendance	Status	Grade	Grade date	Action
Faculty of Education and Rehabilitation Sciences	Krstina	Hadzar	HR-068750569-0785636331	kfu@mservices.life	01 Jan 2022, 11:15	Physical	7	A	24/01/2023	

Rows per page: 10 1-1 of 1



# Incoming Mobility – finished



## Virtual Campus - Administrator

HOME

PERSON

Pending registrations (14)

User management

Teacher management

STUDENTS

Cards

Outgoing pending enrolment (1)

Outgoing active

Outgoing finished

Outgoing history

COURSES

Course management

Incoming pending enrolment (1)

Incoming active (4)

Incoming finished

Incoming history

JOINT PROGRAMMES

My programmes (Administering)

Partner programmes (Participating)

### Incoming finished

Course start date between:

Interval start

24/01/2021



Interval end

24/01/2023



Search



Local course ID	Course	Academic year	Start date	End date	ECTS	Students
32810	Geoinformation Quality	2021/2022	01 Oct 2021	28 Feb 2022	5	
32886	Topography	2022/2023	01 Oct 2022	28 Feb 2023	5	
32888	Hydrographic Survey	2022/2023	01 Oct 2022	31 Jan 2023	5	
33502	Basics of German for Special Purposes	2021/2022	01 Mar 2022	10 Jun 2022	3	
50422	Programming in Geoinformation Systems	2022/2023	01 Dec 2022	28 Feb 2023	6	

Rows per page: 10 1-5 of 5





# Incoming Mobility – finished (Edit grade)

UNIC Home Courses Joint Programmes Administrator Help Sign out

Virtual Campus - Administrator ALEN NOVOSEL University of Zagreb

### Students (Hydrographic Survey)

Home university	First name	Last name	ESI	eMail	Enrolled on	Attendance	Status	Grade	Grade date	Action
Faculty of Mining, Geology and Petroleum Engineering	Anida	Pilav	HR-422104963-5292137079	rm3at1le@alvinneo.com	-	Physical	8	F	28/02/2022	 
UNIC Virtual Campus Support Centre	Sonia	Stipanicev	HR-638303548-7208084261	utkirhursandov@tuddo.me	05 Nov 2021, 07:30	Virtual	8	C	15/12/2022	

Rows per page: 10 1-2 of 2

Rows per page: 10 1-5 of 5



# Incoming Mobility – history



## Virtual Campus - Administrator

- HOME
- PERSON
  - Pending registrations (14)
  - User management
  - Teacher management
- STUDENTS
  - Cards
  - Outgoing pending enrolment (1)
  - Outgoing active
  - Outgoing finished
  - Outgoing history
- COURSES
  - Course management
  - Incoming pending enrolment (1)
  - Incoming active (4)
  - Incoming finished
  - Incoming history
- JOINT PROGRAMMES
  - My programmes (Administering)
  - Partner programmes (Participating)

### Incoming history

Course start date between:

Interval start

Interval end



Local course ID	Course	Academic year	Start date	End date	ECTS	Students
32798	Databases	2022/2023	01 Dec 2022	28 Feb 2023	5	
32799	Differential Geometry	2022/2023	01 Oct 2022	28 Feb 2023	5	
32803	English in Geodesy	2021/2022	01 Oct 2021	28 Feb 2022	3	
32805	Topography	2021/2022	01 Oct 2021	28 Feb 2022	3	
32882	Practical Work with Geodetic Instruments	2021/2022	01 Mar 2022	10 Jun 2022	3	
32886	Topography	2022/2023	01 Oct 2022	28 Feb 2023	5	
32890	Geoinformation Infrastructure	2020/2021	01 Mar 2021	10 Jun 2022	5	

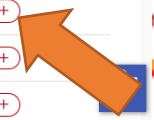



# Incoming Mobility – history

UNIC Home Courses Joint Programmes Administrator Help Sign out

Virtual Campus - Administrator ALEN NOVOSEL University of Zagreb

HOME Incoming history

Students (Practical Work with Geodetic Instruments)

Home university	First name	Last name	ESI	eMail	Attendance	Status
Faculty of Forestry and Wood Technology	Aferdita	Pavlek	HR-241350228-7113655859	fuprodes@seventol.store	Virtual	6

Rows per page: 10 1-1 of 1

JOINT PROGRAMMES My programmes (Administering) Partner programmes (Participating)

32799 Incoming active (4) Differential Geometry 2021/2022 01 Oct 2022 28 Feb 2023 3 (+)

32803 Incoming finished English in Geodesy 2021/2022 01 Oct 2021 28 Feb 2022 3 (+)

32805 Incoming history Topography 2021/2022 01 Oct 2021 28 Feb 2022 3 (+)

32882 My programmes (Administering) Practical Work with Geodetic Instruments 2021/2022 01 Mar 2022 10 Jun 2022 3 (+)

32886 Partner programmes (Participating) Topography 2022/2023 01 Oct 2022 28 Feb 2023 5 (+)

32890 Geoinformation Infrastructure 2020/2021 01 Mar 2021 10 Jun 2022 5 (+)

# The numbers suggest that there are actions that need to be taken

## Virtual Campus - Administrator

ALEN NOVOSEL  
University of Zagreb

- HOME
- PERSON
  - Pending registrations (14)
  - User management
  - Teacher management
- STUDENTS
  - Cards
  - Outgoing pending enrolment (1)
  - Outgoing active
  - Outgoing finished
  - Outgoing history
- COURSES
  - Course management
  - Incoming pending enrolment (1)
  - Incoming active (4)
  - Incoming finished
  - Incoming history
- JOINT PROGRAMMES
  - My programmes (Administrating)
  - Partner programmes (Participating)

### Pending registrations

Staff (13)

Students (1)

#	First name	Last name	eMail	Role	ESI	Actions	Organization name
1.	Dzermal	Kvorka	yagodzinskayairina@fpfc.cf	Organizational Unit Admin (OrgUnit Admin)			Faculty of Organization and Informatics
2.	Paval	Mračić	booba@mumbama.com	Organizational Unit Admin (OrgUnit Admin)			Faculty of Geodesy
3.	Sibila	Puškarović	ajackson2385@easygbd.com	Organizational Unit Admin (OrgUnit Admin)			Faculty of Electrical Engineering and Computing
4.	Martino	Cukor	f70vjbo@king.buzz	Organizational Unit Admin (OrgUnit Admin)			Faculty of Science
5.	Mane	Žičmanović	elfeedko@oanghika.com	Organizational Unit Admin (OrgUnit Admin)			Faculty of Veterinary Medicine
6.	Andy	Klapač	buddy84@dmxs8.com	Organizational Unit Admin (OrgUnit Admin)			Faculty of Food Technology and Biotechnology
7.	Radenko	Jeričević	lukovski@gmailwe.com	Organizational Unit Admin (OrgUnit Admin)			Faculty of Law



# Searching, filtering and selecting columns

## Courses



Name	Description	ECTS Credits	Organization name	University name	ISCED code (Broad field)	Details
Databases <a href="#">↗</a>	Description of Databases	5	Faculty of Mining, Geology and Petroleum Engineering	University of Zagreb	06 Information and Communication Technologies (ICTs)	<a href="#">+</a>
Differential Geometry	Description of Differential Geometry	5	Faculty of Mining, Geology and Petroleum Engineering	University of Zagreb	05 Natural sciences, mathematics and statistics	<a href="#">+</a>
Cadastre	Description of Cadastre	7	Faculty of Mining, Geology and Petroleum Engineering	University of Zagreb	07 Engineering, manufacturing and construction	<a href="#">+</a>
Geodetic Plans	Description of Geodetic Plans	5	Faculty of Mining, Geology and Petroleum Engineering	University of Zagreb	07 Engineering, manufacturing and construction	<a href="#">+</a>
Introduction into Information Society	Description of Introduction into Information Society	3	Faculty of Mining, Geology and Petroleum Engineering	University of Zagreb	03 Social sciences, journalism and information	<a href="#">+</a>

Sort



# Searching

Q datab| X



Search

Name	Description	ECTS Credits	Organization name	University name	ISCED code (Broad field)	Details
<a href="#">Databases</a>	Description of Databases	5	Faculty of Mining, Geology and Petroleum Engineering	University of Zagreb	06 Information and Communication Technologies (ICTs)	<a href="#">+</a>
Spatial Databases	Description of Spatial Databases	6	Faculty of Mining, Geology and Petroleum Engineering	University of Zagreb	06 Information and Communication Technologies (ICTs)	<a href="#">+</a>

Rows per page: 10 ▾ 1-2 of 2 < >



# Selecting visible columns

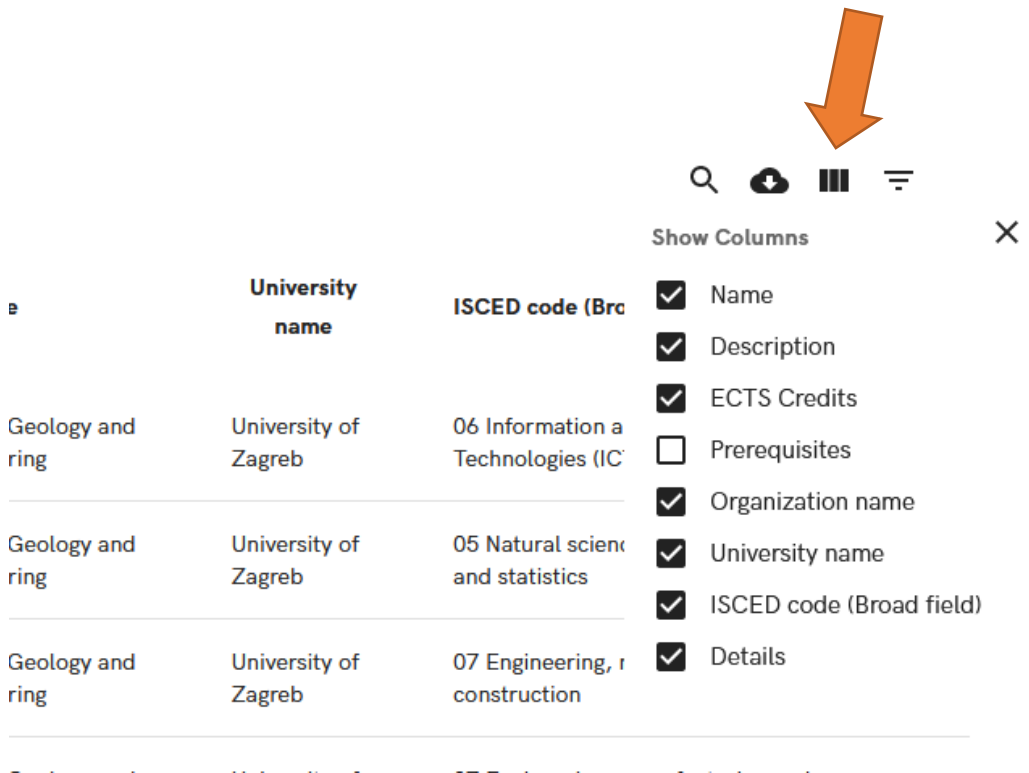

The screenshot shows a table with three columns: 'University name', 'ISCED code (Broad field)', and 'Details'. A 'Show Columns' dialog box is open, allowing the user to select which columns to display. The dialog box has a title 'Show Columns' and a close button 'X'. The list of columns includes 'Name', 'Description', 'ECTS Credits', 'Prerequisites', 'Organization name', 'University name', 'ISCED code (Broad field)', and 'Details'. The 'Prerequisites' option is unchecked, while all other options are checked. An orange arrow points to the column selection icon in the top toolbar.

	University name	ISCED code (Broad field)
Geology and mining	University of Zagreb	06 Information and communication technologies (ICT)
Geology and mining	University of Zagreb	05 Natural sciences and statistics
Geology and mining	University of Zagreb	07 Engineering, technology and construction

Show Columns X

- Name
- Description
- ECTS Credits
- Prerequisites
- Organization name
- University name
- ISCED code (Broad field)
- Details



# Filtering

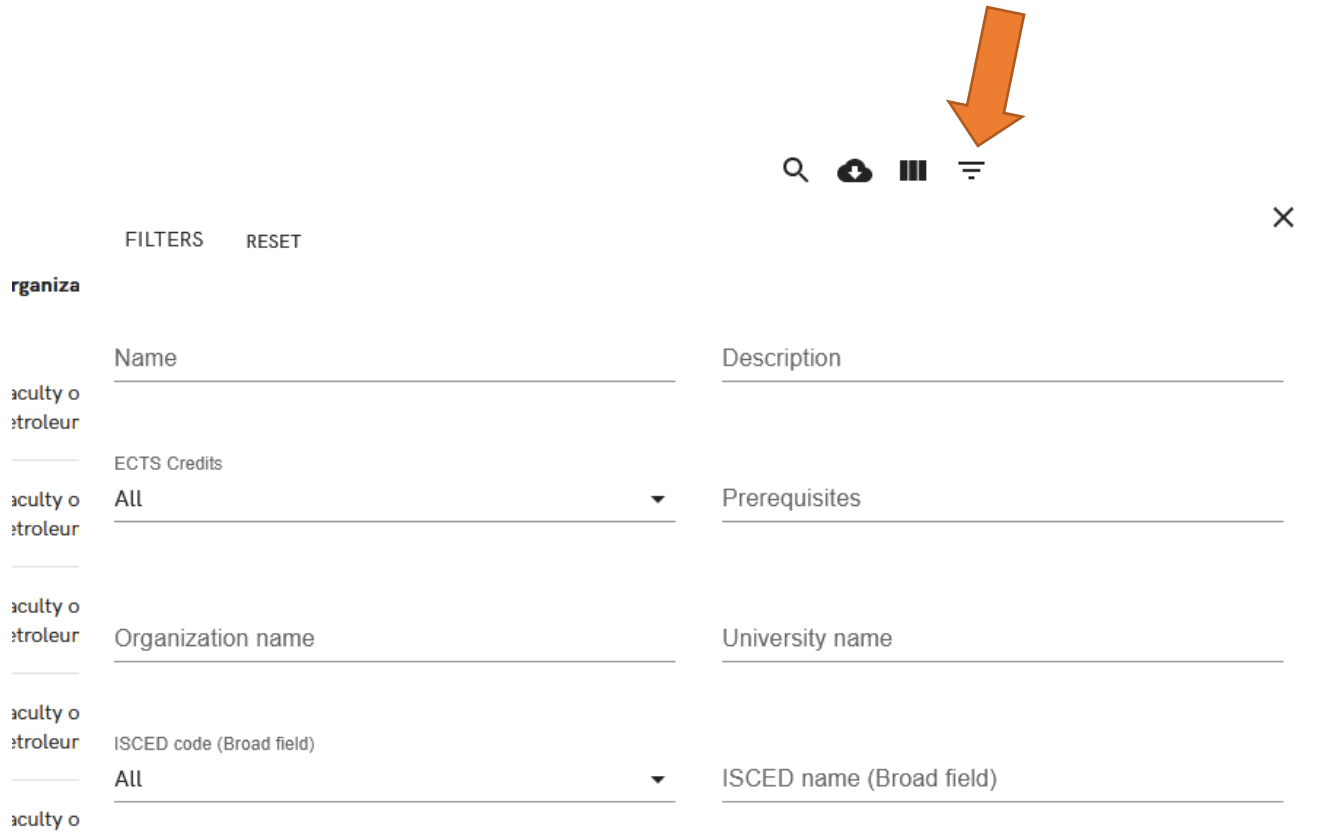

The screenshot shows a user interface for filtering data. At the top right, there is a search bar with a magnifying glass icon, a cloud upload icon, a list icon, and a filter icon. An orange arrow points to the filter icon. Below the search bar, there is a 'FILTERS' section with a 'RESET' button and a close 'X' button. The filter section contains several rows of filterable fields:

- Organization name**: A text input field.
- Description**: A text input field.
- ECTS Credits**: A dropdown menu currently set to 'All'.
- Prerequisites**: A text input field.
- Organization name**: A text input field.
- University name**: A text input field.
- ISCED code (Broad field)**: A dropdown menu currently set to 'All'.
- ISCED name (Broad field)**: A text input field.



# Searching, filtering and selecting columns

## Virtual Campus for Students

BJANKA BAŠIĆ

bjanka.basic@srce.hr

HOME

MY STUDENT CARD

MY COURSES

Enrol in a course

Active courses

Pending enrolment

Course history

### Pending enrolment

Applied filters

data × 5 × 2022 ×



Name	ECTS Credits	Academic Year	Status ID	Status	Action	Organization name	University name
<a href="#">Databases</a>	5	2022	6	dropped off		Faculty of Mining, Geology and Petroleum Engineering	University of Zagreb

Rows per page: 10 ▾ 1-1 of 1 < >



# Current functionalities in the UNIC VC APIs





# API

- Almost everything that can be done in the portals can be done via API
- The goal is to facilitate much more client-friendly API environment
- There are 68 available end-points
- We use swagger docs, which is available at test and production environment



# REST API documentation

GET	/api/getcoursesstatus	Possible course statuses
GET	/api/getprograms	Get list of any sets
GET	/api/gettraces	Get list of roles
<b>Api</b>		
GET	/api/checkavailability(universityId)(startDate)(endDate)	Check for any teaching students for offered courses
GET	/api/checkingavailability(universityId)(startDate)(endDate)	Get list of merging students that have been accepted
POST	/api/revokestudentstatus	
GET	/api/getcountrylocation	List of countries with locations
GET	/api/getjoinprogrammes	List of join programmes
GET	/api/getcoursesforjoinprogramme(joinId)(programmeId)	
GET	/api/getstudentactivecourses(studentId)	
GET	/api/getstudentcoursehistory(studentId)	
GET	/api/getstudentcoursestatus(studentId)	
GET	/api/getcourseinstancesforstudentenrolment(studentId)	
GET	/api/getcardstatus(studentId)	
GET	/api/generatestudentcard(studentId)	Get student virtual card
PUT	/api/activatestudentcard(studentId)	Activate student card
PUT	/api/deactivatestudentcard(studentId)	Deactivate student card
GET	/api/getcourseinstances(courseId)	
POST	/api/enrollcourse	
PUT	/api/cancelcourseenrolment(instanceId)(studentId)	
GET	/api/getpermitedcoursesforexchange	
GET	/api/getstudentcards	
GET	/api/getunjoinprogrammes	
GET	/api/getuncourses	
GET	/api/getunprograms	
PUT	/api/refreshuserdata	
<b>Course</b>		
GET	/api/getcourses	List of all courses
GET	/api/getbasiccoursedata(courseId)	Get basic course data
POST	/api/publishbasiccoursedata	Publish basic course data to the central register
PUT	/api/refreshbasiccoursedata	Edit basic course data
<b>Course instance data</b>		
GET	/api/getcourseinstancedata(courseInstanceId)	Get course instance data
POST	/api/publishcourseinstancedata	
PUT	/api/refreshcourseinstancedata(courseId)	Edit course instance
POST	/api/courseinstanceaddteacher	
DELETE	/api/courseinstanceremoveteacher(courseInstanceId)(teacherId)	
<b>Grades</b>		
POST	/api/registerfinalgrade	
GET	/api/getgrade(homeUniversityId)(studentId)(courseId)(academicYear)(courseInstanceId)	
PUT	/api/refreshfinalgrade(studentId)(courseInstanceId)	
<b>Person registration</b>		
POST	/api/publishpersonregistration	Register person
GET	/api/getpersonregistration(courseId)	Get person registration
GET	/api/getallpersonregistrations(courseId)	Get list of person registrations
PUT	/api/refreshpersonregistration(courseId)	Edit registration

Person
AddressDetails
Country
Course
CourseInstance
CourseInstanceTeacher
CourseStatus
EducationDetails
EducationInstanceData
EducationTrade
EventCourse
EventCourse
GetCourseDetails
GetCountryLocation
GetCourseInstance
GetCourseInstanceOfStudentEnrolment
GetCourse
GetCard
GetJoinProgramme
GetLocation
GetMerged
GetPersonRegistration
GetStudentCards
Grade
JoiningAbility
JoiningSet
JoiningProgramme
Location
Origin
OriginType
OriginAbility
PersonDetailsChange
Person
PersonDigital
PersonRegistration
ProgrammeLevel
PublishCourseData
PublishCourseInstanceData
PublishPersonRegistration
PublishPersonRegistration
RegisterFinalGrade
RegisterPerson
RefreshSystem
RevokeStudentStatus
Role
StudentCard
StudentCourseInstance
Teacher
Teaching
TeacherCourseInstance
TeacherRole



# REST API documentation – end-points

Swagger Powered by SMARTBEAR Select a definition UNIC Rest API

## Unic\_RestApi <sup>1.0</sup> OAS3

/swagger/v1/swagger.json

### Course

- GET** /api/getcourses List of all courses
- GET** /api/getbasiccoursedata/{courseId} Get basic course data
- POST** /api/pushbasiccoursedata Push basic course data to the central register
- PUT** /api/editbasiccoursedata Edit basic course data

### Course instance data

- GET** /api/getcourseinstancedata/{unicCourseInstanceId} Get course instance data
- POST** /api/pushcourseinstancedata
- PUT** /api/editcourseinstancedata/{ciId} Edit course instance
- POST** /api/courseinstanceaddteacher
- DELETE** /api/courseinstanceremoveteacher/{cinstanceId}/{teacherId}

### Grades

- POST** /api/registerfinalgrade
- GET** /api/getgrade/{homeUniversityId}/{studentId}/{courseId}/{academicYear}/{courseInstanceId}
- PUT** /api/editfinalgrade/{studentId}/{courseInstanceId}



# REST API documentation - Schemas

## Schemas

```
AddPersonDetails {
  uniquePersonId integer($int32)
  personalNames* string
    maxLength: 64
    minLength: 0
  familyNames* string
    maxLength: 64
    minLength: 0
  titleBeforeName string
    maxLength: 64
    minLength: 0
  titleAfterName string
    maxLength: 64
    minLength: 0
    nullable: true
  eMail string
    maxLength: 127
    minLength: 0
    nullable: true
  eduGainId string
    maxLength: 127
    minLength: 0
    nullable: true
  esi string
    maxLength: 255
    minLength: 0
    nullable: true
}
```

```
Country {
  countryId integer($int32)
  countryCode* string
    maxLength: 2
    minLength: 0
  countryName* string
    maxLength: 127
    minLength: 0
  euMember* string
    maxLength: 1
    minLength: 1
    pattern: Y|N
  locations > [...]
  orgUnits > [...]
}
```

Course >

CourseInstance >



# APIs testing (Courses GET)

**Course** ^

**GET** /api/getcourses List of all courses v

**GET** /api/getbasiccoursedata/{courseId} Get basic course data ^

Returns basic course data for specific course identified by course id

**Parameters** Try it out

Name	Description
<b>courseid</b> * required integer(\$int32) (path)	<input type="text" value="courseid"/>
<b>x-request-personid</b> * required (header)	<input type="text" value="x-request-personid"/>

**Responses**

Code	Description	Links
200	Requested course data.	No links
	Media type: <input type="text" value="application/json"/> Controls Accept header.	
	Example Value   Schema	
	<pre>{   "unicourseid": 0,   "unicorgunitid": 0,   "localcourseid": "string",   "coursename": "string",   "descriptioncourse": "string",   "ectscredits": 0,   "uri": "string",   "unicprogrammeid": 0,   "prerequisites": "string",   "iscdfieldid": 0 }</pre>	
404	Course with id {id} not found.	No links



# APIs testing (Courses POST)

**POST** /api/pushbasiccoursedata Push basic course data to the central register

Universities push basic course data to the central register (courses that are going to be offered in UNIC virtual campus)

**Parameters** Try it out

Name	Description
x-request-personid <small>required</small>	Person id

(header)

**Request body** application/json

Example Value | Schema

```
{
  "universityId": 15,
  "courseId": "16",
  "courseName": "Physics",
  "description": "Some course description",
  "ectsValue": 30,
  "url": "https://someaddress.com/course",
  "prerequisites": "Some prerequisite for this class",
  "iscedFieldId": 0
}
```

**Responses**

Code	Description	Links
201	Inserted course data.	No links

Media type: application/json

Controls Accept header:

Example Value | Schema

```
{
  "unicCourseId": 0,
  "unicOrgUnitId": 0,
  "localCourseId": "string",
  "courseName": "string",
  "descriptionCourse": "string",
  "ectsCredits": 0,
  "url": "string",
  "unifProgItemId": 0,
  "prerequisites": "string",
  "iscedFieldId": 0
}
```

| 400 | No permission to make changes for another university. Check UniversityId parameter. One or more validation errors occurred. | No links |
| 500 | The server encountered an internal error and was unable to complete your request. Trace id: {0} | No links |

# Open Science Campus @ UNIC VC



# Open Science Campus features

- Built as a part of UNIC Virtual campus
- Provides a searchable portal of UNIC open science resources (publication, datasets, etc) to public
- Provides a portal of UNIC researchers and research groups to public
- Promotes open science by linking to important resources (such as Open Science Course built within UNIC4ER project)





# Open Science Campus main functionalities (1)

- Connects periodically to OpenAIRE's
  - Each included repository has to implement OAI-PMH API to be able to share the data to OpenAIRE
    - which they most likely already do;
    - if not, they should anyway
- Does not provide a web app interface to edit the publication's data.  
All data changes must be done in the original repo



## Open Science Campus main functionalities (2)

- Connects periodically to ORCID via ORCID API and pulls the publicly available information about researchers
- Enables the researcher to log in to UNIC VC Researcher portal
- Enables the researcher to establish a research group and/or join other groups within UNIC



# The operation and the future of VC



## Current status of the system operations

- UNIC VC currently developed and operated by University Computing Centre, University of Zagreb (SRCE)
- 3 different environments – development, testing and production
- All set up in SRCE's data centres
- Support available through [unicvc-support@srce.hr](mailto:unicvc-support@srce.hr) alias
- SRCE provides the maintenance and the support
- Development and operational costs partly covered by UNIC projects



# UNIC 2.0

- A long term commitment to UNIC VC
  - Support for ICT for all partner UNIs
  - Support for administrators for all partner UNIs
- Further improvement of supported processes (EWP, ESC, ...)
- Maintenance, support and operation



# Thank you

unicvc-support@srce.hr



This material is available under the International Creative Commons License *Attribution-NoDerivatives* 4.0 International.

According to the Open Access Policy, Srce ensures that all research data made by Srce is accessible and free to use by the general public, especially educational and professional information and content derived from the actions and work of Srce.

[www.srce.unizg.hr/en](http://www.srce.unizg.hr/en)

[creativecommons.org/licenses/by-nd/4.0/deed.en](http://creativecommons.org/licenses/by-nd/4.0/deed.en)

[www.srce.unizg.hr/oa-and-oer](http://www.srce.unizg.hr/oa-and-oer)

